

TYLÖ®

Introducing the
new generation of
sauna heaters and
steam generators

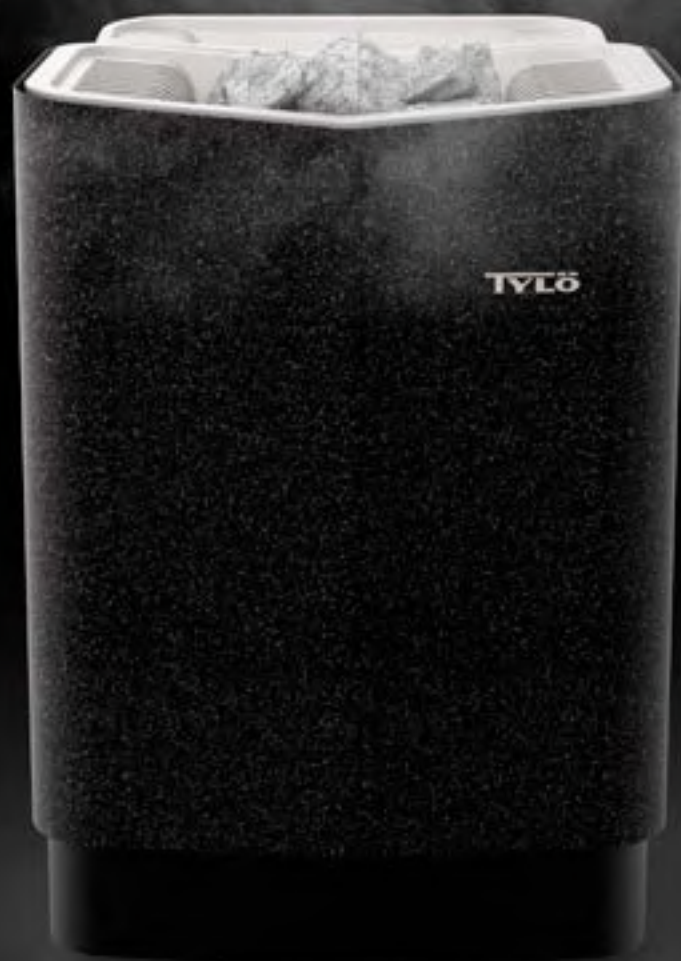

Sauna heaters
Steam generators
Control panels



Contents

About Tylö	4
Electric sauna heaters	6
Six good reasons to choose a Tylö heater	8
Choosing the right heater	10
Soft Sauna - What's your temperature?	11
Home electric sauna heaters	12
Sense Sport	13
Sense Elite/Pure	13
Sense Combi Elite/Pure	13
Expression & Expression Combi	13
Professional electric sauna heaters	14
Sense Commercial	14
Tylarium - for professional use	15
Steam generators	16
The new steam generation	18
Steam Commercial & Steam Home	20
Control panels - Elite & Pure	22
Buying guides/specifications	26
Electric sauna heaters	28
Relay boxes	30
Accessories	30
Tylarium	30
Steam generators	31
Control panels	32

About Tylö

OVER 60 YEARS OF CONSISTENTLY HIGH QUALITY

Tylö AB is a well-established Swedish manufacturer with considerable world market shares and all the resources necessary to ensure industry leading technology and design as well as after-sales support. Our highly successful concept is built on offering products of high quality, which promote relaxation, enjoyment and the pleasure of sauna bathing. All the products that bear our name have been developed and manufactured by Tylö. Today our products are exported to more than 90 countries on every continent, and export sales currently account for more than 70% of our total production. We know that our products maintain a high level of quality. That's why you can feel at ease thanks to the 5-year materials warranty we offer with our products for residential installations.

MADE IN SWEDEN

The Tylö factory is located in Halmstad on the west coast of Sweden. We have been here since 1950 and continue perfecting our products which are manufactured from scratch solely by us.

ENVIRONMENTAL CONCERNS A PRIORITY

When you choose a product from Tylö, high quality comes standard. Our quality-mindedness is reflected in all aspects of

our operations, from design and product development to the choice of materials, manufacturing processes, service and support. We are also committed to the environment. Our manufacturing processes are completely clean. There are no harmful emissions from any stage of the production process. The timber we use comes from responsibly managed forests in Scandinavia, the Baltic states and North America. None of our timber is taken from the world's precious rainforests. All plastic components are manufactured from environmentally certified raw materials.

DEVELOPMENT

The Tylö Research & Development Centre is devoted to constantly developing and perfecting our products and concepts. Collaborating with external test facilities, labs, universities and other institutions help us to keep up to date with the very latest advances in new manufacturing processes, safety developments and consumer legislation. Sophisticated equipment is used to carry out all the many tests that are necessary for Tylö products to be awarded international seals of approval from a variety of official safety testing authorities. Our holistic approach and the fact that we develop all of our products in-house means that we have complete control of every step of the process, right down to the smallest of nuts and bolts.



INNOVATIVE DESIGN

Smart solutions in the form of well-conceived energy-saving functions and by working diligently in creating products and concepts that adhere to the highest possible safety standards, continues to be our way in maintaining our position as market leaders. For our customers, this hard work manifests itself most clearly in the attractive design and ease of use of our products.

STRONG SUPPORT

We do our utmost to get things right from the outset, however, questions may pop up from time to time regarding an installation or the operation of a product. Our well-trained and competent local distributors are on hand to answer your questions as clearly and efficiently as possible, and will ensure effective and quick problem-solving. We feel this provides the shortest route between us as sauna experts and you as a sauna customer.



Electric sauna heaters

Our sauna heaters are made to the highest standards for durability and longevity. We at Tylö are avid sauna bathers and make sure that our products are made for perfect sauna experiences. The engineering that goes into our heaters provides excellent heating performance and maximum efficiency. This gives you the possibility to enjoy a relaxing and hot sauna in just 25 minutes.



Intelli.air

Faster heat distribution and heater longevity through Tylö patented air chambers.



Thermosafe

Unique protective coating, never too hot to touch.



Standby

Less energy consumed and faster reaction time to heat sauna or steam room.

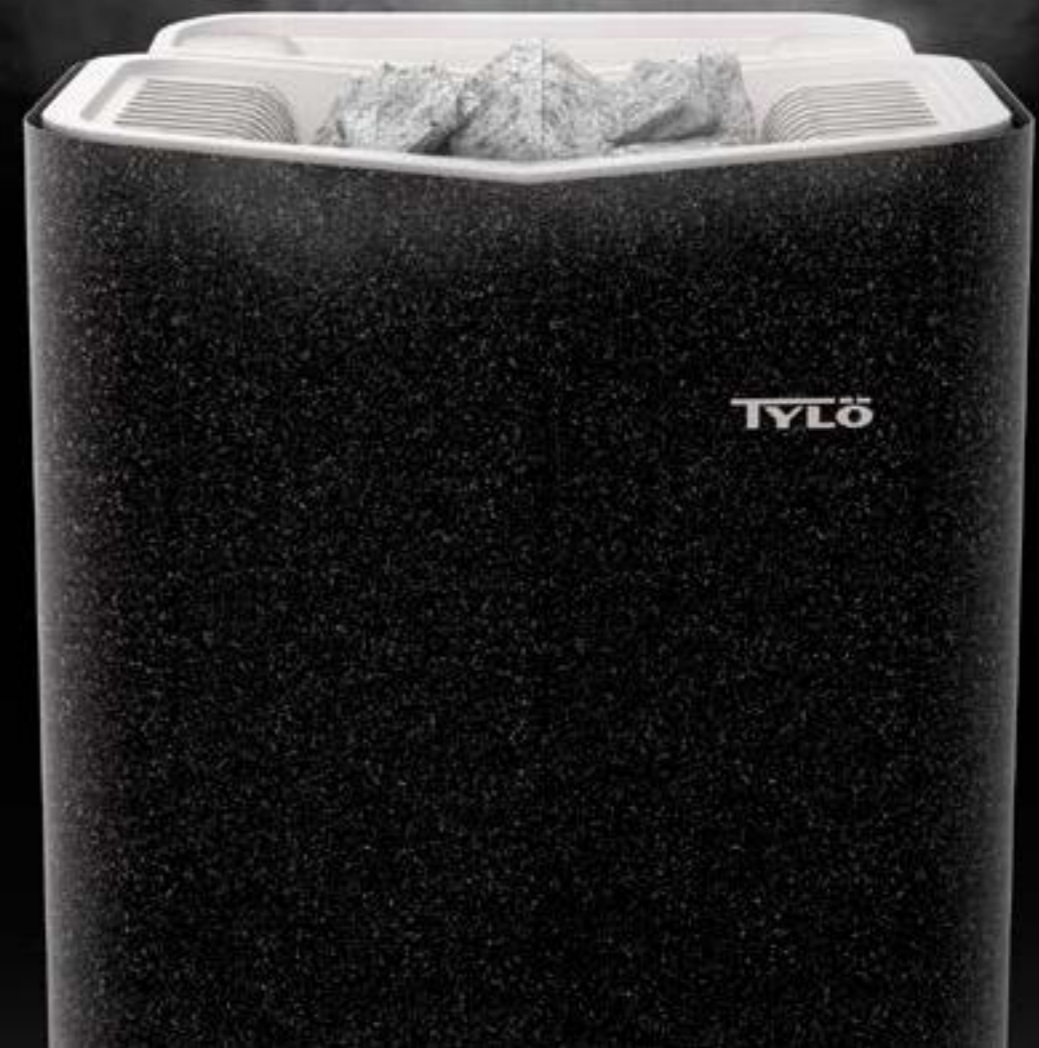

Six good reasons to choose a Tylö heater

ELEGANT DETAILS

All Tylö heaters are manufactured by sauna bathers for sauna bathers. This means that each heater has been carefully designed to deliver the ultimate sauna experience. The grill on Tylö's original heater is angled to ensure optimal distribution of hot air. The built-in water reservoir creates a more comfortable and gentle climate - exactly as it should be in a genuine Tylö sauna.

FAST HEATING THAT SAVES ENERGY

Tylö's original heaters all heat a sauna extremely quickly - up to twice as fast as any other heater. Tylö's unique, twin side air chambers provide enhanced hot air distribution (taking as little as 25 minutes to reach a normal sauna temperature of 80°C).

Moreover, with the patented divided output feature, Tylö heaters can realize energy savings of up to 30%, making them an energy-efficient choice. The divided output feature means that the sauna heater automatically switches to energy-saving mode when the temperature reaches the desired level and maintains it for the length of time you spend in the sauna.

All in all, this is a financially-sound, long-term investment if you are looking for fast and comfortable sauna heating.

SAFETY - A HIGH PRIORITY

Overheat cut-offs, thermostats and temperature sensors are vital components that are selected with meticulous care to ensure maximum safety.

It is also assuring to know that Thermosafe™, Tylö's unique protective coating, prevents the exterior from becoming too hot to the touch.



EFFECTIVE WATER SPRINKLING

Unlike many other sauna heaters, Tylö's original heater has a deep, centrally-located stone compartment. This ensures that almost all the water sprinkled over the stones turns into steam.

MADE IN SWEDEN

Tylö manufactures its sauna heaters completely in-house, without compromising quality. The heating elements, which are the heart of the heater, are manufactured in a closely monitored process to ensure reliable performance and long life.

The choice of materials, such as a stainless steel stone compartment and aluminium top, reflects Tylö's high quality standards for all of its products. This is important and good for you, no matter how frequently or seldom you take a sauna.

Thanks to in-house production and meticulous quality control the consumer can be assured that a Tylö heater is a reliable purchase.

PRODUCT TESTING AND CERTIFICATIONS

All Tylö heaters are being tested throughout the entire manufacturing process. It is very important for us that our products have all the necessary certifications in the operating country - providing our customers peace-of-mind.

Choosing the right heater

In order to reach the perfect sauna experience and the greatest energy efficiency combined, it is important to consider the physical properties of your sauna room. After that, it is more about comfort and convenience. Here are the three crucial steps towards your sauna desires:

- 1 FIND OUT THE SIZE AND VOLUME OF YOUR SAUNA ROOM** - See table below. Don't forget to consider the amount of glass surfaces as well as significant use of stone. Both require a more powerful heater.
- 2 DETERMINE YOUR SAUNA PREFERENCES** - See pages 11-13. Different heaters provide different sensations. Some can manage all of them.
- 3 CHOOSE HOW YOU PREFER TO CONTROL YOUR SAUNA** - See pages 22-25. Select from in-room, remote, digital and analogue solutions.

Find the perfect heater for your sauna room:

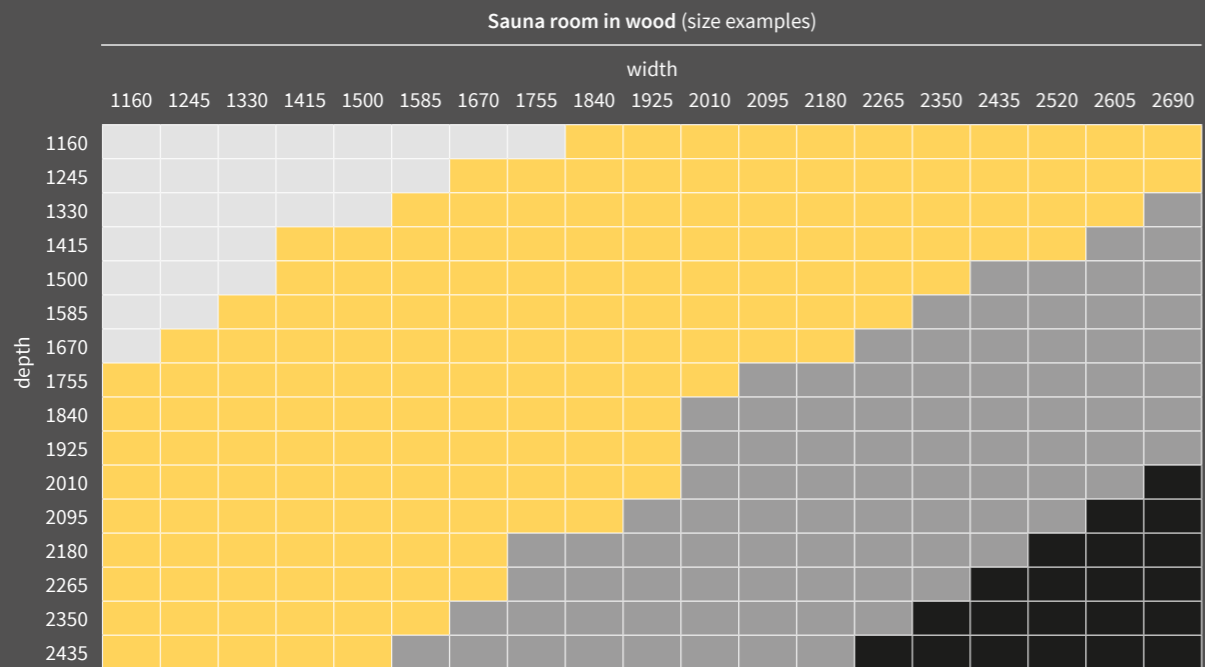

Note: if your sauna room's walls have tiles, stones or glass add 1m³ to your sauna room's volume for every m² of 'heavy material'.

Heater models & energy effect

<ul style="list-style-type: none"> Compact 2/4 kW Combi Compact H1 4 kW 	<ul style="list-style-type: none"> Sense Sport 6.6 kW Sense Pure 6.6 kW Sense Elite 6.6 kW Sense Combi Pure 6.6 kW Sense Combi Elite 6.6 kW 	<ul style="list-style-type: none"> Sense Sport 8 kW Sense Pure 8 kW Sense Elite 8 kW Sense Combi Pure 8 kW Sense Combi Elite 8 kW Expression Pure 10 kW* Expression Elite 10 kW* Expression Combi H2 10 kW** Air Pure 10.5 kW 	<ul style="list-style-type: none"> Sense Combi Pure 10.5 kW Sense Combi Elite 10.5 kW Expression Pure 10 kW* Expression Elite 10 kW* Expression Combi H2 10 kW Air Pure 10.5 kW
---	--	--	---

* with Relay box Commercial
** with Relay box 45

Visit tylo.com for more information



Soft Sauna with Sense Combi heater - introducing steam for a gentler experience

SENSE COMBI Smart technology enabling a more sensuous experience.

Sense Combi is one of our most versatile heaters and one that perfects the sauna experience for the whole family without losing the possibility for an individually tuned sauna experience.

WE CALL IT SOFT SAUNA

The Soft Sauna experience has been developed with families and togetherness in mind.

In keeping with Soft Sauna versatility, it never eliminates outstanding possibilities for individually tuned sauna experiences. Invite your friends and family, select a therapeutic essential oil and feel the warmth and gentle steam engulf you.

SET YOUR TEMPERATURE, YOUR MOISTURE, YOUR EXPERIENCE

Soft Sauna picks up where traditional saunas leave off. You may prefer a hot and quick

sauna, others like to linger in mild temperatures, enjoying gentle steam and aromatic fragrances. Imagine having a family home spa with the resources of a professional spa where you can relax together, exquisitely engulfed in steam and aromatic scents. Or, enjoy the relaxing dry heat of a traditional sauna.

Different bathing forms

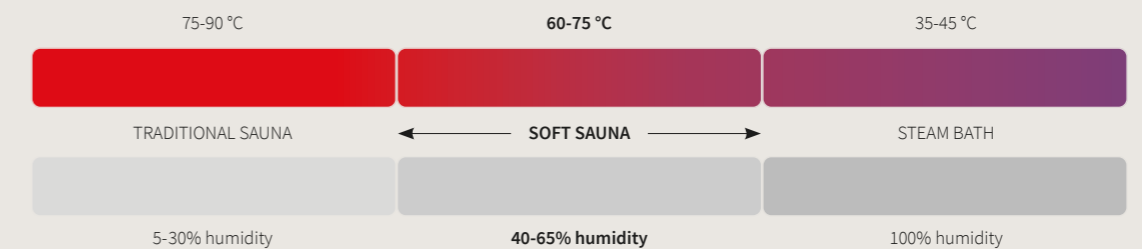



SENSE SPORT

- 1 6.6 kW - for sauna volume 4-8 m³.
8 kW - for sauna volume 6-12 m³.
- 2 Offers a classic dry sauna.
- 3 Control panel with thermostat and mechanical timer integrated into the base of the heater.



SENSE ELITE/PURE

- 1 6.6 kW - for sauna volume 4-8 m³.
8 kW - for sauna volume 6-12 m³.
- 2 Offers a classic dry sauna.
- 3 Choose either control panel Elite or Pure to your Sense heater. The control panel is included in the price.



SENSE COMBI ELITE/PURE

- 1 6.6 kW - for sauna volume 4-8 m³.
8 kW - for sauna volume 6-12 m³.
10.5 kW - sauna volume 10-18 m³.
- 2 Offers both dry, wet and steam sauna (Soft Sauna).
- 3 Choose either control panel Elite or Pure for your Combi heater. The control panel is included in the price.

For more information on control panels Elite or Pure go to page 24 & 25.

Home electric sauna heaters

Sense heaters - multi everything

ENJOY VARIETY

Tylö's electric sauna heaters are one of the keys to enjoying your home spa – exquisitely enveloped in gentle steam and aromatic fragrances or relaxing in traditional dry sauna heat. The way we want to spend our time in a sauna is a matter of personal preference and depends on the needs of the moment; a classic dry sauna, or a more humid Soft Sauna experience. Tylö's electric sauna heaters always deliver top performance, thanks to a combination of functionality, aesthetics and environment. Together with attractive surroundings, this creates the conditions for a perfect sauna experience.



Intelli.air

- Home spa capabilities



Thermosafe

- Low energy consumption

- Modern styling



Standby

- Innovative features

- Wide range in power output



Expression heaters - expressing your sense of style

Elegance, purity and sophistication - our line of Expression heaters will add that extra touch of luxury to your sauna room.

EXPRESSION

- 1 10 kW - For sauna volume 10-18 m³.
- 2 Offers a classic dry sauna.
- 3 Add control panel Elite or Pure with Relay Box Commercial.

EXPRESSION COMBI

- 1 10 kW - For sauna volume 10-18 m³.
- 2 Offers both dry, wet and steam sauna (Soft Sauna).
- 3 H2 control panel and relay box RB45 are included in the price.

AVAILABLE IN COLOURS

 Black

 Champagne

 Copper

More information in buying guide on page 26 and onwards.



Selma Spa in Sunne, Sweden

Professional electric sauna heaters

Shaped by real life use

For decades Tylö has been the obvious choice for saunas in hotels, clubs, swimming baths and sporting facilities. Professionally managed environments like these prioritize reliability and low energy consumption, while frequent use subjects both designs and materials to punishing treatment.

Thanks to their tried-and-tested construction, intelligently conceived functions and materials of the very finest quality, our Sense Commercial heaters are more than a match for tough use and demanding conditions. No wonder they're a common sight in public saunas all over the world!

The Sense Commercial heaters are equipped with a number of features for smart, efficient and practical use in commercial situations. The stand-by mode senses user frequency and automatically adjusts power output accordingly. Combined with the WiFi-based control panel Elite, it is possible to control multiple sauna or steam rooms from a single point of access, such as a front desk, or mobile device. As an extra safety measure, the sauna will not start if the sauna door has been left open, or if something has been placed on top of the heater.



SENSE COMMERCIAL

- 6.6 kW - For sauna volume 4-8 m³
8 kW - For sauna volume 6-12 m³
10 kW - For sauna volume 10-18 m³
16 kW - For sauna volume 15-35 m³
20 kW - For sauna volume 22-43 m³
- Offers a classic dry sauna in public settings.
- Add control panel Elite together with relay box Commercial.



Tylarium - for professional use

Combining the Steam Commercial generator, Sense Commercial sauna heater with steam distributor, and the Elite control panel makes a Soft Sauna experience possible in public and commercial spaces as well.

Representing a new way of enjoying heat and humidity, Soft Sauna is a modern take on the traditional sauna. With lower temperatures and plenty of steam, Soft Sauna will give your customers a spa experience to remember and return to. Adding aromatic essential oils to the steam will provide a scented sauna session that is even more relaxing.

Elite control panel

Control and monitor your sauna from the office or reception using nothing but local WiFi, a mobile device and Tylö's WellAccess™ app. The app was specially developed to optimize your sauna experience and is compatible with iOS, Android and desktop PCs.



Calculate how much you can save with our Standby tool on www.tylo.com

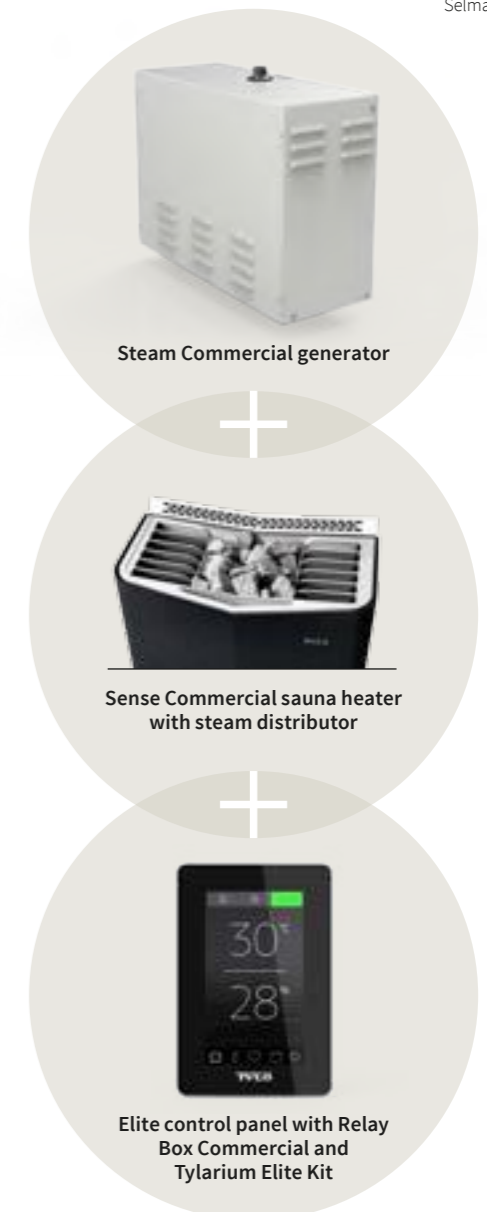

Steam generators

Our newest line of steam generators are engineered to provide top performance under demanding conditions and a variety of water types without failing. Smart control units give you full access to current status and functions. And most importantly our steam generators will envelope you in rich, dense and warm steam and relaxation.



Speed heat

Greater energy efficiency through faster warm-up times.



Standby

Less energy consumed and faster reaction time to heat sauna or steam room.



The new steam generation

FOR DECADES we have been supplying high quality products to provide personal well-being and an improved standard of living for our customers. With our new generation of steam generators and smart digital control panels we are taking the steam room experience to a new level.

QUALITY
For over 30 years we have been manufacturing steam generators at our factory in Sweden and have taken great pride in producing top quality products. Smart technical solutions form the basis for sustainable products and are a key contributing factor to our industry leading position.

COMMUNICATION
Our control panels allow you to regulate up to three steam generators from the same location. Control your steam bath directly via the control panel or set it up so that you can control it from your computer or mobile device. The option for wireless network connection allows remote control.

INTELLIGENCE
Our new steam generators for home and public environments set a new standard with their smart solutions for optimum effect. Two-way communication between the control panel and the steam generator facilitates an effective overview of all functions, with updates in real-time.

SUSTAINABILITY
With scrupulous quality control, smart technology and a strong focus on water and energy consumption, we have designed Tylö's steam generators for minimal impact on our environment.

LESS MAINTENANCE
We design our steam generators with great attention to detail. They should run for many years with no interruption and a minimum of maintenance. They come with an automatic emptying function that is set according to the water quality in your area.

HIGH LEVEL OF COMFORT
Whether our steam generators are installed in a home or public setting, they are designed to offer top-quality enjoyment and comfort without interruption. The convenient Multi-Steam function ensures uninterrupted operation in heavily-utilised facilities, and the Bahia steam outlet, which can be added as an optional extra, is specially designed to spread abundant, billowing steam with minimal noise and risk of burns.

ENERGY SAVING
Scandinavian design has always been influenced by consideration for efficiency and the overall feel. Accordingly, we have employed technology to make our steam generators as efficient as possible. The stand-by mode option and our "divided output" function can reduce energy consumption by up to 30%. Once the air in the steam room has reached the desired temperature, the output of the steam generator drops to a suitable level to maintain this temperature.

It's all about water

IT'S NOT JUST STEAM
Our new steam generators set a new industry standard with their innovative solutions based on experience. For you, it's all about enjoying quality time relaxing in a soothing steam bath. While for us, it's all about ensuring that you can enjoy fantastic, problem-free relaxation.

WE MAKE SURE EVERYTHING OPERATES SMOOTHLY
To ensure the steam is generated in the best way, it is important to analyse the water used. It's not just about calcium deposits, but also about the conductivity of the water, which may differ in different regions. The quality of the water has a major bearing on both the function and service life of your steam generator.

If you are not sure about the water in your region contact your local dealer to test the water before ordering your steam generator system. Sometimes your local water company may be able to provide the information you need.



It is essential that the analysis takes into account both the degree of hardness and the conductivity of the water. Softer water yields increased conductivity and increased risk of foaming, which can affect the efficiency of the steam generator.

Water quality	Water treatment, low consumption	Water treatment, high consumption
Soft water: 0-4 dH	No additives needed	Softener needed
Medium hard water: 4-14 dH	Softener needed	RO filter needed
Hard water: 14-24 dH	Softener and RO filter needed	Softener and RO filter needed

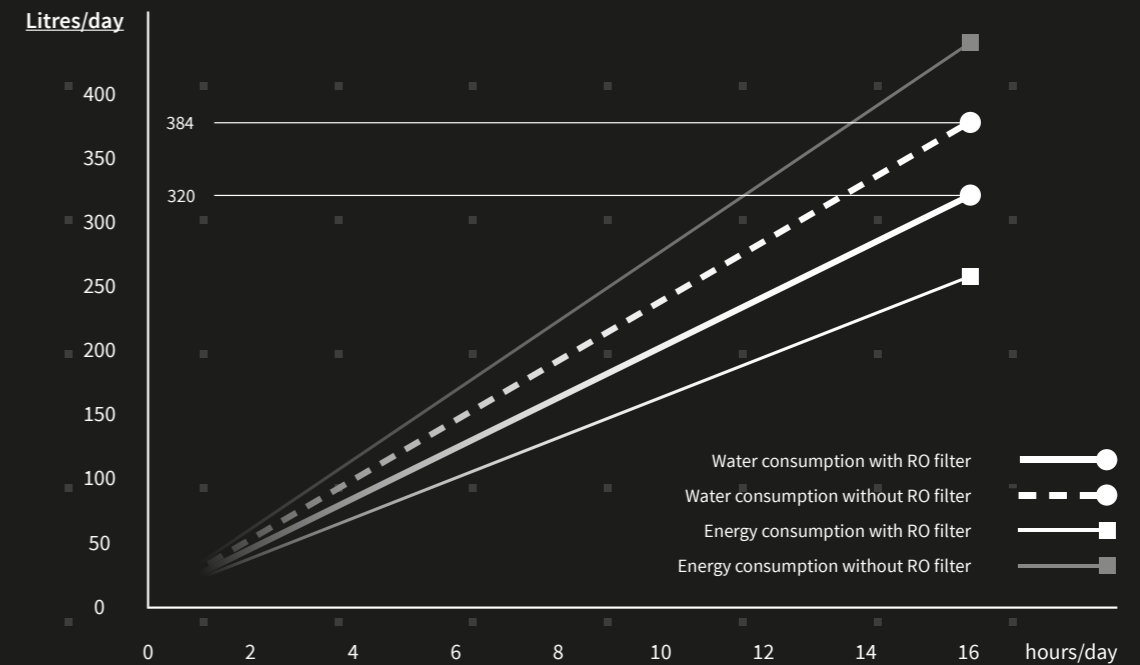

For reliable, continuous operation, service life and minimum energy and water consumption, we strongly recommend an RO filter for your steam generator. This is especially applicable for operation in public environments where the conductivity of the water is high.



Smarter steam generation

Leave the challenges of everyday life behind and enjoy the perfect end to your day in a relaxing steam bath.

Tylö has a strong tradition of providing steam generators for public and private use. Our latest series is fitted with a state-of-the-art control unit to ensure precise operation. Control the steam, lights, timer and other features at the simple touch of a button. Add fragrances and relax. Indulge yourself and all your senses.



Total control with Elite

Control and monitor your steam room from a distance using nothing but local WiFi, a mobile device and Tylö's app WellAccess™. The app is especially developed to optimise your steam experience and is compatible with iOS, Android and desktop PCs.

Steam Commercial & Home
- Automatic empty
- Automatic flush
- Energy saving feature
- Replaceable heater
- Limescale repellent electrodes
- Level detection outside the water tank
- Automatic shut-off if water level low
- Electronic temperature limiter
- Stand-by
- Fragrance pump control (Steam Commercial)
- Fan control



STEAM COMMERCIAL

Our Steam Commercial steam generator is equipped with a large water tank and is designed to easily connect to our Multi-Steam function – an effective way to avoid stoppages in frequently used systems.



STEAM HOME

Our latest compact and effective steam generator for home environments. It offers new and improved features such as stand-by, an aromatherapy option and improved protection against stoppages.

Full product range and buying guide on page 26 and onwards.

Control panels

Our control panels are developed and manufactured in-house at Tylö to ensure perfect functionality. Proprietary technology and straight forward solutions work in unison for seamless and trouble free communication with your sauna or steam room.

Control your sauna from anywhere - all you need is WiFi

Elite & WellAccess™

EFFORTLESS BATHING

The new multi-disciplinary control panel Elite from Tylö is packed with advanced features, thanks to its internal processor and operating system. In addition to highly personalized settings, the Elite can be individually programmed according to your own schedule.

Add features such as auxiliary fans, fragrance pumps or sound systems – the Elite control panel handles it all with clear and concise precision. The crystalline 4.5-inch screen delivers real-time status on every aspect of your sauna bath. Naturally, it includes steam and temperature settings and WiFi app-connectivity.

WELLACCESS™ - AN ALL-NEW CONTROL PANEL APP FOR MOBILE DEVICES AND COMPUTERS

In order to increase comfort, convenience and a better user experience adapted to people's everyday living patterns, we recently launched WellAccess™, an ingenious computer and smartphone app.

The user interface, developed for mobile devices and personal computers, perfectly emulates that of the sauna control panel. Through sensible engineering, the outcome is highly usable functionality, allowing sauna bathers to log on to the control panel through the smartphone app over their local WiFi network and remotely control most aspects of their sauna.

On both the control panel itself and via WellAccess™, it is possible to create and save several different user profiles and favourite settings, and set different schedules. In commercial settings, it is possible to manage multiple units from one point of access, and set unique profiles for different locations.



- Set temperature and humidity
- Can create multiple user profiles
- Control sauna/steam via WiFi and app
- Control several units at a time
- Set different schedules for different week days
- Set specific profiles for specific times or dates
- Instant fault notification



WI-FI

Desktop PC

Android/iOS



Pure

INTUITIVE DESIGN AND FEATURES

The elegant, compact design of Tylö's Pure control panel makes it the go-to choice for those who value functionality and advanced technology without compromising on aesthetics.

The ultra-thin black control lights up and lets you set the lighting, temperature and sauna time easily with only a few touches. Of course, choosing the default start time means you can step into a wonderfully hot sauna as soon as you get home.

Buying guides

Some of us have huge bathrooms, some have only a tiny space to spare. Some prefer plenty of steam, others like their sauna hot and dry. No matter what your preferences and conditions are, Tylö can provide you with the optimal sauna experience. In this buyer's guide we have gathered all the information you need in order to choose the perfect sauna solution to suit your specific needs. If you have questions, don't hesitate to contact one of our sales representatives for guidance.

Buying guide - Sauna heaters



COMPACT

AIR

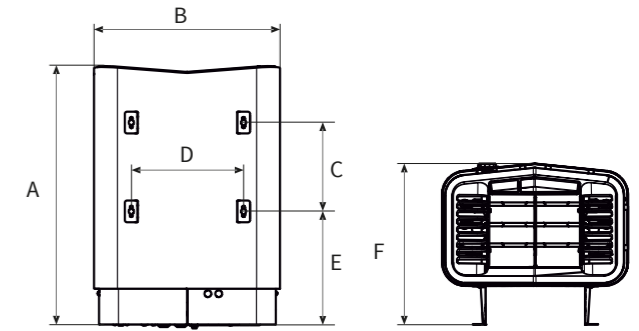

Home electric sauna heaters



Model	Item no.	Output kW	Sauna volume m ³	Min. distance to side wall (mm)	Min. ceiling height (mm)	Suitable control panel	Weight heater + rocks (kg)	A	B	C	D	E	F
Compact 2/4	62202000	2.2-4.5	1.2-4.5	50	1900	Built-in	6+7	400	310	195	260	135	170
Combi Compact 4 with H1	62305000	4	1.2-4.5	50	1900	H1 included	12+7	400	310	-	245	-	225
Sense Sport 6	61001018	6.6	4-8	110	1900	Built-in	17+20	559	431	206	262	262	375
Sense Sport 8	61001012	8	6-12	110	1900	Built-in	17+20	559	431	206	262	262	375
Sense Pure 6	61001031	6.6	4-8	110	1900	Pure included	17+20	559	431	206	262	262	375
Sense Pure 8	61001033	8	6-12	110	1900	Pure included	17+20	559	431	206	262	262	375
Sense Elite 6	61001034	6.6	4-8	110	1900	Elite included	17+20	559	431	206	262	262	375
Sense Elite 8	61001035	8	6-12	110	1900	Elite included	17+20	559	431	206	262	262	375
Sense Combi Pure 6	61001080	6.6	4-8	110	1900	Pure included	23+20	559	431	280	185	210	375
Sense Combi Pure 8	61001082	8	6-12	110	1900	Pure included	23+20	559	431	280	185	210	375
Sense Combi Pure 10	61001086	10.5	10-18	110	1900	Pure included	23+20	559	431	280	185	210	375
Sense Combi Elite 6	61001036	6.6	4-8	110	1900	Elite included	23+20	559	431	280	185	210	375
Sense Combi Elite 8	61001038	8	6-12	110	1900	Elite included	23+20	559	431	280	185	210	375
Sense Combi Elite 10	61001084	10.5	10-18	110	1900	Elite included	23+20	559	431	280	185	210	375
Expression 10 Black	61001000	10	10-18	200	1900	Pure or Elite with relay box Commercial	29+12	730	500	-	-	-	200
Expression 10 Champagne	61001003	10	10-18	200	1900	Pure or Elite with relay box Commercial	29+12	730	500	-	-	-	200
Expression 10 Copper	61001006	10	10-18	200	1900	Pure or Elite with relay box Commercial	29+12	730	500	-	-	-	200
Expression Combi 10 Black	62001010	10	10-18	200	1900	H2 and relay box 45 included	30+12	730	500	-	-	-	200
Expression Combi 10 Champagne	62001013	10	10-18	200	1900	H2 and relay box 45 included	30+12	730	500	-	-	-	200
Expression Combi 10 Copper	62001016	10	10-18	200	1900	H2 and relay box 45 included	30+12	730	500	-	-	-	200
Air 10 Pure	61001042	10.5	10-18	120	1900	Pure included	29+100	923	410	-	-	-	252

Professional electric sauna heaters

Sense Commercial 6	61001025	6.6	4-8	110	1900	Pure or Elite with relay box Commercial	16+20	559	431	206	262	262	375
Sense Commercial 8	61001027	8	6-12	110	1900	Pure or Elite with relay box Commercial	16,5+20	559	431	206	262	262	375
Sense Commercial 10	61001090	10	10-18	150	1900	Pure or Elite with relay box Commercial	32+25	650	650	310	600	165	400
Sense Commercial 16	61001092	16	15-35	150	2100	Pure or Elite with relay box Commercial	32+25	650	650	310	600	165	400
Sense Commercial 16 3x230V	61001100	16	15-35	150	2100	Pure or Elite with relay box Commercial	32+25	650	650	310	600	165	400
Sense Commercial 20	61001094	20	22-43	150	2100	Pure or Elite with relay box Commercial	32+25	650	650	310	600	165	400
Sense Commercial 20 3x230V	61001102	20	22-43	150	2100	Pure or Elite with relay box Commercial	32+25	650	650	310	600	165	400
Megaline OC 10	64050230	10.5	8-13	25	1900	H2 with relay box WE14	27+60	725	540	-	-	-	500
Megaline OC 12	64050234	12	10-18	65	2100	H2 with relay box WE14	28+60	725	540	-	-	-	500
Megaline OC 15	64050235	15	14-24	65	2100	H2 with relay box WE14	29+60	725	540	-	-	-	500
Megaline SK 18	64050236	18	18-30	140	2100	H2 with relay box WE14	41+120	700	895	-	-	-	520
Megaline SK 21	64050238	21	24-36	140	2100	H2 with relay box WE14	42+120	700	895	-	-	-	520
Megaline SK 26	64050240	26	30-46	140	2100	H2 with relay box WE14	44+120	700	895	-	-	-	520

Buying guide - Relay boxes, Accessories and Tylarium

Relay boxes for sauna heaters

	Model	Item no.	Size WxHxD mm
	Relay box Commercial	71016012	482x293x75
	Relay box RB30	71016006	230x310x75
	Relay box RB60	71016007	305x350x125
	Relay box WE14	71016010	340x300x125

Accessories

	Model	Item no.	Features
	External switch	90908047	On/off switch to control the sauna from locations other than where the control panel is installed.
	Door contact	90908035	Prevents unintentional start-up of the sauna by remote control if the sauna door is open.
	Elite recessed frame	90001056	Specially designed to work with Elite control panel. The control panel and mounting frame are fully integrated into the wall, regardless of whether they are located outside or inside the sauna room.
	Steam outlet Commercial	90029263	Steam outlet for Tylarium. The Tylö steam outlet Commercial improves the distribution of steam in your sauna room. Specially designed for Sense Commercial heaters 10-20 kW.
	Steam outlet Bahia Home	90029254	High-efficient and low-noise steam outlet for smaller steam rooms. Made of high-gloss plastic and tempered safety glass panels with a protective coating. Size: 280 x 180 mm (BxH).
	Steam outlet Bahia Pro	90029252	Made of tempered safety glass with an exclusive Corian front panel, highly suitable for large steam rooms. Extremely quiet in operation. Size: 500 x 300 mm (WxH).
	Legs for Sense 6/8	90001060	Legs for all Sense sauna heaters 6.6-8 kW. Color black.
	Legs for Sense Combi 6/8/10	90001061	Legs for all Sense Combi sauna heaters 6.6-10.5 kW. Color black.
	Sauna stones Mini Compact, 7 kg	90141005	Natural stones of black diabase that tolerate rapid heating and cooling. Suitable for our Compact and Combi Compact heaters.
	Sauna stones, 14 kg	90141000	Natural stones of black diabase that withstand rapid heating and cooling. One carton (approx. 14 kg) is sufficient for our Expression heaters. Sense Commercial 10-20 heaters requires two cartons.
	Sauna stones, 20 kg	90141050	Natural stones of black diabase that withstand rapid heating and cooling. One carton (20 kg) is sufficient for Sense heaters 6.6-8 kW and Sense Combi heaters 6.6-10.5 kW.
	Sauna stones for Air, 20 kg	90141007	Larger diabase stones, suitable for Air sauna heater. The stones provide better air circulation and retain heat longer. One box holds 20 kg. For Air heater you will need 5 boxes (100 kg).

Tylarium

Sauna volume m ³	Sauna heater kW	Relay box	Steam generator kW	Control panel	Required	Optional
10-18	Sense Commercial 10	Commercial	Steam Commercial 9	Elite	Tylarium Elite Kit Item no. 71016000	Steam outlet
15-35	Sense Commercial 16	Commercial	Steam Commercial 9	Elite	Tylarium Elite Kit Item no. 71016000	Steam outlet
22-43	Sense Commercial 20	Commercial	Steam Commercial 12	Elite	Tylarium Elite Kit Item no. 71016000	Steam outlet









Buying guide - Steam generators

Model	Item no.	Output (kW)	Steam room's min./max. volume (m ³)				Steam production (kg/h)	Size in mm (LxWxH)	Suitable control panel
			Light wall made of glass, plastic, Elysée Excellent room, etc.		Heavy wall made of tiles, concrete, stone, etc.				
			With ventilation	Without ventilation	With ventilation	Without ventilation			
Steam Home	66210120	3	-	max. 3	-	max. 2	3.5	480 x 350 x 159	Elite or Pure
		6	3 - 8	4 - 15	2 - 5	2.5 - 8	8		
		9	6 - 16	13 - 24	4 - 10	7 - 16	12		
Steam Commercial	66210010 66210015 66210020	9	6 - 16	13 - 24	4 - 10	7 - 16	12	585 x 415 x 230	Elite or Pure
		12	14 - 22	22 - 30	8 - 15	14 - 20	16		
		15	18 - 25	28 - 38	10 - 19	18 - 25	20		
2 x 9 2 x 12 2 x 15 Steam Commercial		18	20 - 30	28 - 40	13 - 20	18 - 30	24	585 x 415 x 230	Elite or Pure
		24	28 - 40	38 - 50	18 - 30	28 - 40	32		
		30	36 - 50	56 - 76	32 - 42	42 - 57	40		
3 x 9 3 x 12 3 x 15 Steam Commercial		27	38 - 45	46 - 60	28 - 40	38 - 52	36	585 x 415 x 230	Elite or Pure
		36	43 - 60	58 - 70	38 - 50	48 - 60	48		
		45	54 - 75	84 - 114	47 - 63	60 - 75	60		
VA 6	66202020	6	3 - 8	4 - 15	2 - 5	2.5 - 8	8	570 x 224 x 485	CC50, CC300 or H1
VA 9-K	66203021	9	6 - 16	13 - 24	4 - 10	7 - 16	12		
VA 12	66204020	12	14 - 22	22 - 30	8 - 15	14 - 20	16		
VA 18	66205020	18	20 - 30	28 - 40	13 - 20	18 - 30	24		
VA 24	66206020	24	28 - 40	38 - 50	18 - 30	28 - 40	32		
VA 3x9**		27	38 - 45	46 - 60	28 - 40	38 - 52	36		
VA 3x12**		36	43 - 60	58 - 70	38 - 50	48 - 60	48		
VB 2/4/6*	66201830	2.2 4.5 6.6	- max. 4 3 - 8	max. 2.5 max. 5.5 4 - 15	- max. 2.5 2 - 5	max. 1.5 max. 3.3 2.5 - 8	3 5.5 8	445 x 130 x 415	CC50, CC300 or H1

* 2.2/4.5/6.6 kW convertible for single, two or three phase connection. ** Only one control panel is required for connection.

Buying guide - Control panels

Control panels for sauna and steam

	Model	Item no.	Size WxHxD mm	Features		For sauna or steam?	Suitable sauna heater	Relay box required?	Suitable steam generator
	Pure	72001410	86x86x8	Thermostat controlled touch control panel, for installation inside or outside the sauna or steam room.		Both	Sense Pure - included	No	Steam Home
							Sense Combi Pure - included	No	
							Air - included	No	
							Expression	Yes, relay box Commercial	
							Sense Commercial 6-20 kW	Yes, relay box Commercial	
	Elite	72005000	85x127x12	The multi-disciplinary control panel is packed with advanced features, thanks to its internal processor and operating system. Naturally it includes energy saving functions and WiFi/App connectivity.		Both	Sense Elite - included	No	Steam Home
							Sense Combi Elite - included	No	Steam Commercial
							Expression	Yes, relay box Commercial	
							Sense Commercial 6-20 kW	Yes, relay box Commercial	
	H1	72001020	80x140x19	H1 is equipped with touch-control and shows temperature and time in operating mode. Can be set for start within a 24-hour period and has a running time between 0-23 hours. Also equipped with a switch for lighting, 12h/24 format and multiple languages. Compatible with Tylö's older heaters Sense Plus, Sense SK (via RB30/60) and SDK/SD (via RB30/60).		Both	Combi Compact 4 - included	No	VA
							Expression	Yes, relay box RB30	VB
							Sense Commercial 6-10 kW	Yes, relay box RB30	
							Sense Commercial 16-20 kW	Yes, relay box RB60	
	H2	72001100	80x140x19	Same functions as the H1. But with the H2 control panel, you can even preset the start program for one week in advance complete with repetitions, do trouble-shooting and control the atmospheric humidity in the sauna room. Compatible with Tylö's older heater Sense Combi.		Sauna	Expression Combi - included	Yes, relay box RB45 - included	
							Megaline OC 10-15 kW	Yes, relay box WE14	
							Megaline SK 18-26 kW	Yes, relay box WE14	
	CC50	71214005	130x190x27	Has a display for time and temperature, switch for lighting and security code function. Programmable for 1, 3, 12 and 24 hours or continuous operation. 0-10 hour preset. Compatible with Tylö's older heaters Sense Plus, Sense SK (via RB30/60) and SDK/SD (via RB30/60).		Both	Expression	Yes, relay box RB30	VA
							Sense Commercial 6-10 kW	Yes, relay box RB30	VB
							Sense Commercial 16-20 kW	Yes, relay box RB60	
	CC300	71115150	130x190x27	Can be set to run for between 1 and 24 hours and has a display that indicates temperature, remaining operating time, day and time. In addition, the CC300 comes with a switch for lighting, memory features, security code and energy-saving, stand-by function. Compatible with Tylö's older heaters Sense Plus, Sense SK (via RB30/60) and SDK/SD (via RB30/60).		Both	Expression	Yes, relay box RB30	VA
							Sense Commercial 6-10 kW	Yes, relay box RB30	VB
							Sense Commercial 16-20 kW	Yes, relay box RB60	
	TS 30-6	70202038	195x225x89	Thermostatically-controlled panel for Sense Commercial heaters. For wall-mounted installation outside the sauna (max. distance 1.8 m). Equipped with timer for 6-hour operating time. Compatible with Tylö's older heaters Sense SK, SDK 10 and SD 16.		Sauna	Expression	No	
							Sense Commercial 6-16 kW	No	
	TS 30-12	70212020	195x225x89	Thermostatically-controlled panel for Sense Commercial heaters. For wall-mounted installation outside the sauna (max. distance 1.8 m). Equipped with timer for 12-hour operating time. Compatible with Tylö's older heaters Sense SK, SDK 10 and SD 16.		Sauna	Expression	No	
							Sense Commercial 6-16 kW	No	



TYLO

c Sys
ED



Tylö dealer