

TYLÖ[®]
for the senses



TYLÖ SAUNA
COMPLETE SAUNA ROOMS



Experience and read more about Tylö - for the senses, at www.tylo.com/forthesenses



Close your eyes.
Open your senses.

Tylö touches all your senses.

Step in Open your senses. Feel your thoughts clear and enjoy the calmness that spreads through your body. Your muscles relax, the tension is released. Your thoughts wonder, your dreams become reality. In the warmth the truth emerges, your soul is laid bare. We want to create the ultimate enjoyment that opens the door to what is inside you. This is our promise to you. Design and quality are our great passions. Our Scandinavian designers set themselves the task of making the sauna environment an aesthetic exclamation mark. Ever since our founder Sven-Olof Janson built his first unit in the 1950s, we have been responsible for a series of ground-breaking innovations within saunas, showers and steam baths. Every little detail is infused with consideration and love. Open the door and feel, open your senses.

Tylö sees the whole picture

Take your place. Expand your soul. Feel the harmony in the details, experience the whole. We view the bathroom as a world of wellbeing and enjoyment, where the sauna is at the very heart. Each part comes together in a well-balanced and beautiful unit.

Sauna heaters

With its sober design, our classic Tylö heater blends into the environment. The unit has a sleek V-shaped front and boldly designed grill that effectively distributes the warm air. The decorative stone compartment is made of stainless steel.

Fittings

The living material in the fittings arouses your senses and gives you a powerful overall experience. The lines are simple and clean, with beautifully carved wood. Select the fittings and the equipment that best suit your particular bathroom. At Tylö we care about personal expression.

Doors & walls

Doors, walls and glazed sections can be configured in a great many different ways to suit your layout. The flexible walls mean that most standard rooms can be installed mirror fashion. We have made use of every single centimetre to ensure that the sauna room will fit in your bathroom or spa area.

Light

Incorporating decorative shades, dampened lighting tracks and inset downlights a soft glow will be spread over the sauna. The warm, modest light captivates the entire bathroom and creates a suggestive feeling.

Accessories

Small details can make a big difference. A few well chosen accessories such as an hour-glass, a thermometer, a ladle, a bucket and a towel rack allow you to give your sauna room a distinctive character all of its own. The accessories are available in aluminium or with decorative wooden detailing to match your fittings.

Fragrances

Our delightful fragrant essences give your bathroom an extra dimension. A drop or two in a ladle of water will release an invigorating scent when sprinkled over the sauna stones. The oils spread a wonderful fragrance of eucalyptus, peppermint, pine, lavender, cinnamon or citrus.



Read more about Tylö quality at www.tylo.com/quality



Discover Tylo's products at www.tylo.com

Take a look at www.tylo.com. There you can explore our products in more detail. We have visualised the products in an exciting way to enable you to see all the benefits they have to offer. Click on the various points and see what happens. Allow yourself to be inspired!



Find more information on www.tylo.com

The symbols in the catalogue mean that there is more information about the products on our website. Type in www.tylo.com/productname if you would like to know more about a particular item. You will then be forwarded directly to that product. You can also download information about the products at www.tylo.com/download



You can find more information about the product on our website. Here you can read about dimensions, materials and much else besides. Get to know the product a little better.



You can find more pictures on our website. See the product from other angles, look at the beautiful details and experience the whole.



Interactive visualisation is available on our website. Here you can turn the product this way and that, and experience all the benefits at close quarters. A fun way of learning more.



Plan your own home spa online. Draw and fantasise, lose yourself in your dreams for a while. Insert our products and see how beautiful the end result will be.

www.TYLO.com/product name





Tylö parts catalogues

TYLÖ SAUNA

A catalogue filled with inspiration about our complete range of sauna rooms and our classic Tylö heater. We have everything from compact home bathroom models to large, exclusive facilities for hotel suites. Read all about our prefabricated turnkey solutions.

TYLÖ STEAM

Includes Tylö's delightful steam baths, steam showers and exclusive shower solutions. A steam bath is a gentler form of bathing, with a high level of humidity that reaches pleasantly into your soul. Tylö offers complete solutions including steam generators, control panels, doors, wall and seat sections.

TYLÖ SELF-ASSEMBLY SAUNA

For those of you who want to build your own sauna. Tylö offers prefabricated sauna rooms including fittings, walls, floor, ceiling, heater and ventilation. The catalogue contains detailed instructions that make the work both simple and enjoyable.

TYLÖ HOME SPA

For those who desire their own home spa. Tylö offers a complete package, including a sauna, steam sauna, steam bath, multi-shower and conventional shower. The catalogue contains a selection of our best products, which will transform your bathroom into an exclusive, delightful spa.

TYLÖ INFRA

Infra is an alternative form of bathing that can also be combined with a traditional sauna. This is a wonderful experience that spreads a feeling of wellbeing throughout your entire body as the warm, infrared rays touch your skin. Read all about Tylö's innovative infra panels.

TYLÖ ACCESSORIES

Small details can make a big difference. In this catalogue we have collected and displayed all the accessories that give your sauna and steam bath a distinctive character all of their own. These include buckets, ladles, thermometers, hour-glasses, fragrant essences, towel racks, loudspeakers, spot lighting and lampshades.



See all of our sauna rooms at
www.tylo.com/saunarooms



A piece of furniture in the bathroom

Scandinavian design

Sometime by yourself, a personal oasis. Here and now, every day. Our exclusive sauna rooms have made Tylö a synonym for quality among sauna enthusiasts the world over. Maximum enjoyment in a small space. Simple, clean lines, proud Scandinavian design. Treat yourself to a sauna room when building or renovating your ideal home. There is often enough space – you only need a few square metres. We have many different models to choose from, in a range of sizes and finishes. If you require specific dimensions or an unusual design, our skilful craftsmen are here to help you. Our sauna rooms come as a prefabricated self-assembly package and are simple to install.

Tylö sauna ix210



A complete home spa in a minimum of space

Step into the warmth, feel your thoughts clear. Caress your hand over the soft wood and experience the beautifully carved surface.

Tylö sauna ix210 offers an ingenious compact design measuring just 2.8 m², and provides a complete home spa including a traditional sauna, a gentler steam sauna, a soothing steam bath and a conventional shower. Even where space is at a premium, you can still enjoy the good life in the form of delightfully relaxing and invigorating saunas and steam baths in the comfort of your own home. It's a revolution in home spa design, compact enough to fit in a regular bathroom instead of in your garage or in your garden shed! We call it the Tylö Impression, because we know that it will not leave you unmoved.

Tylö sauna ix210(s)

Tylö sauna ix210 comprises two sections, for showers/steam baths and saunas/steam saunas respectively.

The exterior finish is available in white, black or wenge, a durable brown wood veneer. Doors and wall sections can be configured in many ways to suit different layouts and bathroom requirements.

Floor decking ix210 heat-treated ash
(Art. no. 9607 4765)

Bench, white i66
(Art. no. 9607 4750)

Lighting track i199 H/T 12 V 8.2 W
(Art. no. 9607 4760)



ix210 white



ix210 black



ix210 wenge



www.tylo.com/impressionix210

Tylö Impression sauna and shower

Tylö Impression is based on a unique system of profiles that gives you the maximum freedom of choice in the minimum amount of space by allowing you to vary the configuration, exterior finishes and bathing experiences. Shown here is the Tylö sauna ix210 with two cubicles, one for sauna bathing and one for showers, in a space of just 2125 x 1325 mm (external dimensions). The sauna cubicle comes complete with two wooden sauna benches, providing plenty of room for two adults and two children.

The lacquered aluminium profiles of the frame conform to a registered design that ensures maximum versatility within the unique Tylö system. They simply clip together, so no screws are needed for assembly. The sleek lines of the design are a joy to behold – and simplicity itself to clean.

Impression Cross Over + Steam gives you an innovative mix of different bathing experiences. A shower column and sauna cubicle are included as standard (ix210). If you wish, you can choose to replace the standard shower column with a steam shower column (ix210s). This means you can also enjoy a steam bath in the shower cubicle. The sauna heater is purchased separately to allow you to choose a traditional heater or a Tylö Combi heater so that you can also bathe in a steam sauna.

A flexible system

Walls, glass sections and doors can be assembled in a variety of different ways to suit your bathroom layout. You can also place all interior fittings – except for the sauna heater – where you wish. Here is an example of a common configuration.

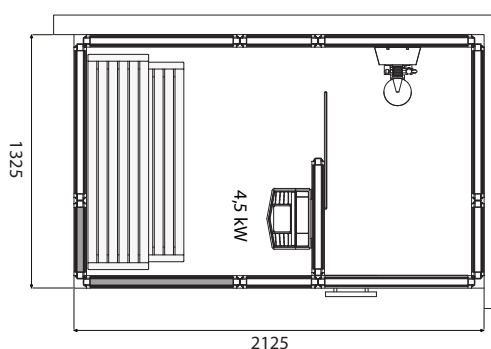

Select heater

Choose a Compact 2/4 for dry saunas and classic sauna bathing, or a Combi 4 RC if you also wish to enjoy a steam sauna function.



The sauna benches are made of dark ash, heat-treated to cope with years of use, heat and humidity. The inside walls are clad in beautiful, knot-free, blonde aspen wood of the very highest quality.



The shower cubicle is constructed of aluminium, glass and high-gloss acrylic. These materials are unaffected by humidity, so you can install a steam shower column if you wish. Access to the sauna is via a sliding door in the spacious shower cubicle.

Tylö sauna Impression

A small sauna for the small bathroom

Tylö's new Impression sauna range takes up a minimal amount of space from as little as 1.3 m². This sauna solution can contain both a traditional sauna and a gentler steam sauna. It's a revolution in home spa design, compact enough to fit in even a small bathroom.

The sauna cubicle comes complete with two sauna benches at different levels. The lacquered aluminium profiles of the frame conform to a registered design that ensures maximum versatility within the unique Tylö system. They simply clip together, so no screws are needed for assembly. The sleek lines of the design and the detachable jalousie are a joy to behold – and simplicity itself to clean.



The sauna benches are made of dark ash, heat-treated to cope with years of use in a sauna climate. The inside walls are clad in beautiful, knot-free, blonde aspen wood of the very highest quality.



Tylö sauna i1313



Tylö sauna i1515/c

Impression sauna room

The Impression material kit includes: Thermally-insulated wall and ceiling sections, door section, fittings in aspen and heat-treated ash (dark), backrest, lighting, hygrometer/thermometer, aluminium floor frame, detachable jalousie, corner and ceiling mouldings, vent and assembly hardware.



www.tylo.com/impressionsauna

Exclusive all-in-one instrument

All Impression sauna rooms are supplied with an exclusive hygrometer/thermometer with built-in LED lighting. Style and functionality in one – as well as atmospheric lighting.

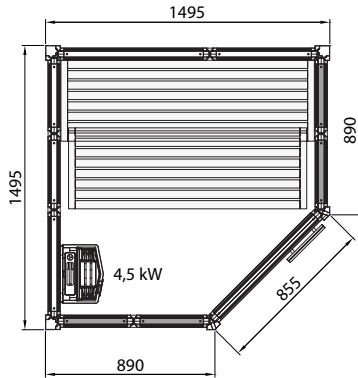
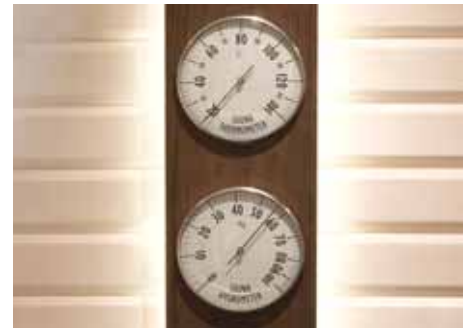

Ingenious compact design

Our Swedish designers set themselves the task of combining practical functions with an elegant setting where you can relax and pamper yourself in style. However, the Impression sauna also stands out by virtue of its ingenious compact design and its small dimensions. Here you can see an example of a common configuration for a Tylö sauna i1515/c. See more dimensional diagrams on page 17.

Select heater

Choose a Combi Compact 4 RC heater for a complete steam sauna solution – although of course you can also enjoy a traditional sauna with this unit. Choose the Compact 2/4 for a simple yet functional solution for traditional sauna bathing.



We build – you reap the benefits

Buying a prefabricated sauna room is not only the simplest and swiftest way to turn your dream of a sauna into reality. It's also the smartest and the safest, too. That way you can be sure of a really well-made sauna that will serve you well, year after year after year.



Selected timbers – a proper sauna requires the proper wood. Tylö uses only genuine timber of the very highest quality.

Robust construction – Tylö saunas are built to cope with all types of bathing climate.

Effective insulation with mineral wool in wall and ceiling sections and heat-resistant polyester seals.

Perfect fit every time makes assembling walls, ceiling and fittings simple and straightforward.

Glazed wall sections give a sensation of space inside the sauna and keep bathers in touch with what is going on outside.

Tempered safety glass for extra security in all glazed surfaces.

Perfect ventilation with air supply and exhaust air vents placed in accordance with the Tylö principle. This makes use of the laws of physics to spread heat naturally and create different temperature zones in the sauna.

Broad, comfortable benches in solid wood with a sturdy construction and velvet smooth surfaces.

Contoured backrests enhance comfort in the sauna and help tired muscles to relax.

Elegant skirting panels screen off the gaps between the benches.

Subdued lighting with light fittings concealed behind backrests or lampshades.

Prepared for simple electrical installation – conduits in the wall sections make electrical installation work quick and easy.

The best sauna doors – Tylö has a wide choice of alternatives, all built to cope with the huge differences in temperatures inside and outside the sauna without warping or becoming deformed.

5 year material guarantee – clear proof of the high quality of Tylö saunas.

Tylö sauna Vision

Round Vision sauna

The uniquely innovative shape of Round Vision has set a totally new standard for what a sauna room can look like. With its large expanses of glass, beautifully rounded front and frame of beech, this sauna is not only an aesthetic exclamation mark in any contemporary bathroom, but also an ingenious solution for providing a sensation of space in settings where space is limited.



www.tylo.com/roundvision



Space Vision

The name says it all. Space Vision has been designed for those who enjoy saunas surrounded by light and a sensation of space. Among the most distinctive characteristics of this exclusive range of sauna rooms are the bold sweep of the rounded corner, the generous expanses of glass and the tasteful combination of different woods.



www.tylo.com/spacevision



Midi Vision

Yes, it is possible for a sauna to feel roomy and yet be compact in size at the same time! The new Midi Vision concept provides visible proof! This exclusive but welcoming design with practical corner access has been specially developed to fit elegantly into both public facilities and home spas. The beautifully rounded glass door can be placed in either corner to open left or right, thus increasing the opportunities to install Midi Vision as part of a well-planned home spa.



www.tylo.com/midivision



Vital Vision

Vital Vision is without a doubt the most exclusive of all our prefabricated sauna rooms. With its specially selected materials, boldly innovative design and generously equipped features, Vital Vision raises the standard in any relaxation suite to the level of a custom-made sauna room.



www.tylo.com/vitalvision



Tylö sauna Grand Luxe & Classic



Grand Luxe

Grand Luxe rooms come in the same sizes and basic models as the Classic series. The difference is that all the interior fittings are in natural blonde aspen. Here too, you can give free rein to your imagination. All you need is a little woodstain, for example. The welcoming glass door, which can be hung to open either left or right, has a beautifully finished wooden handle and is set firmly into a solid wooden frame. Tinted safety glass and a magnetic door catch come as standard.



www.tylo.com/grandluxe



Classic

The standard Classic model is the epitome of a traditional sauna, both inside and out. At the same time, it's easy to adapt a Classic sauna room to its surroundings. Choose Classic Special if you want to add a finish that blends with other materials to create a harmonious whole in your bathing environment. When it comes to fittings for your sauna, the only limits are those set by your imagination.



www.tylo.com/classic



Tylö glazed sections

Prefabricated glazed sections in 6 mm tempered safety glass with solid wood frames in blonde aspen or beech, which is slightly darker in shade. The glazed sections in aspen are recommended for use in Classic and Grand Luxe sauna rooms. The layouts on the previous spread show which wall sections may be replaced by glazed sections.



Glazed section 95

Aspen (Art. no. 9512 6051)

Beech (Art. no. 9104 5060)

Smoked, tempered safety glass in a solid wood frame.
Height 1900 mm, width 964 mm.

Glazed section 95 VENT

Aspen (Art. no. 9512 6053)

Beech (Art. no. 9104 5050)

As above, but with wall vent and wall panel for installing a sauna heater.

Glazed section 52

Aspen (Art. no. 9512 6055)

Beech (Art. no. 9104 5040)

Smoked, tempered safety glass in a solid wood frame.
Height 1900 mm, width 530 mm.

Glazed section 52 VENT

Aspen (Art. no. 9512 6057)

Beech (Art. no. 9104 5030)

As above, but with wall vent and wall panel for installing a sauna heater.



www.tylo.com/glazedsections

Your freedom of choice is part of our design plans

Here is a layout chart of our complete range of prefabricated sauna rooms. You can see sizes, the correct location of the sauna heater and the layout of the interior fittings. All our sauna rooms can also be installed mirror fashion (except Vital Vision). You can also see which standard wall sections can be replaced by glazed sections. For the sake of clarity we also indicate the optimum heater output for each of the rooms. All you need to do is measure, compare and decide which sauna room is the best for you.

Classic & Grand Luxe

(All models have an external roof height of 2010 mm)

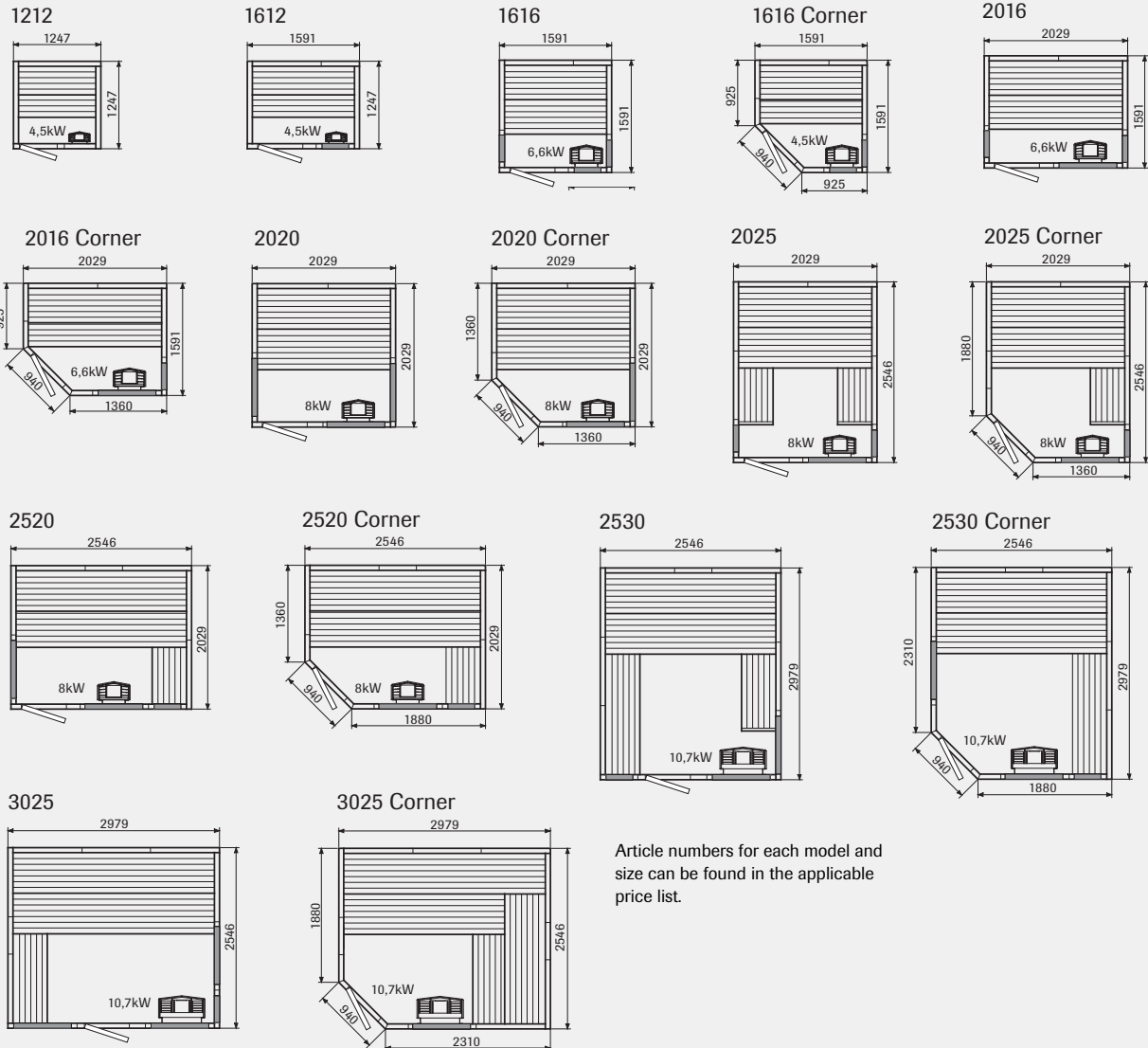

Round Vision 150

(External roof height 2030 mm)

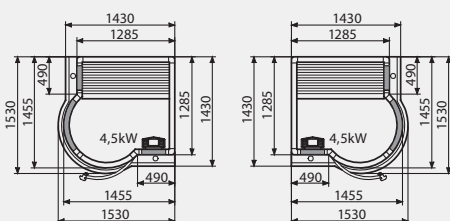

Round Vision 200

(External roof height 2030 mm)

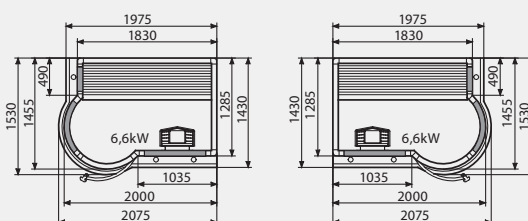

Wall sections shaded in dark grey can be replaced by glazed sections. Please state which wall sections you wish to replace with glazed sections when ordering your sauna room.

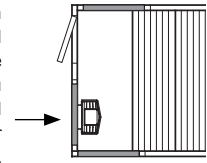

Space Vision 150, corner entrance.
(External roof height 2030 mm)

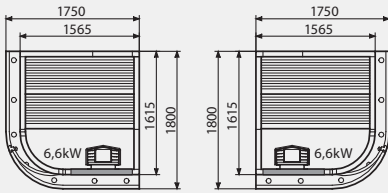

Space Vision 150, front entrance.
(External roof height 2030 mm)

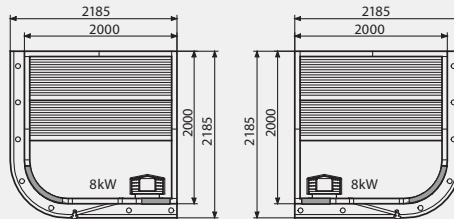

Space Vision 250, front entrance.
(External roof height 2030 mm)

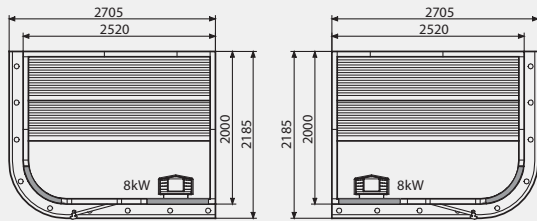

Midi Vision
(External roof height 2030 mm)

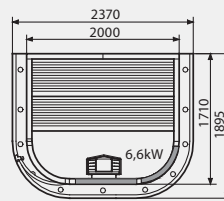

Vital Vision*
(External roof height 2030 mm)

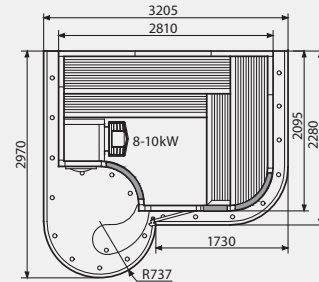

*The interior cannot be installed mirror fashion.

Impression sauna
(External roof height 2100 mm)

i1309

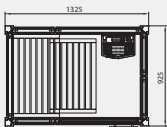

i1313

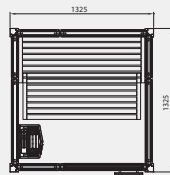

i1713

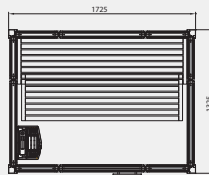

i1115/c

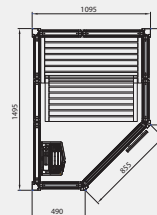

i1515/c

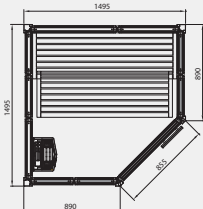

i1915/c

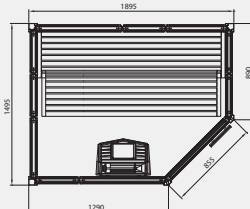

ix210

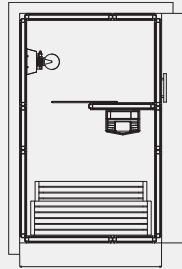

Tylö sauna ix210s: with Compact or Combi heater in the sauna and a steam shower column.

Tylö sauna ix210: with Compact or Combi heater in the sauna and a shower column.



TYLÖ



See all of our sauna heaters at
www.tylo.com/saunaheaters

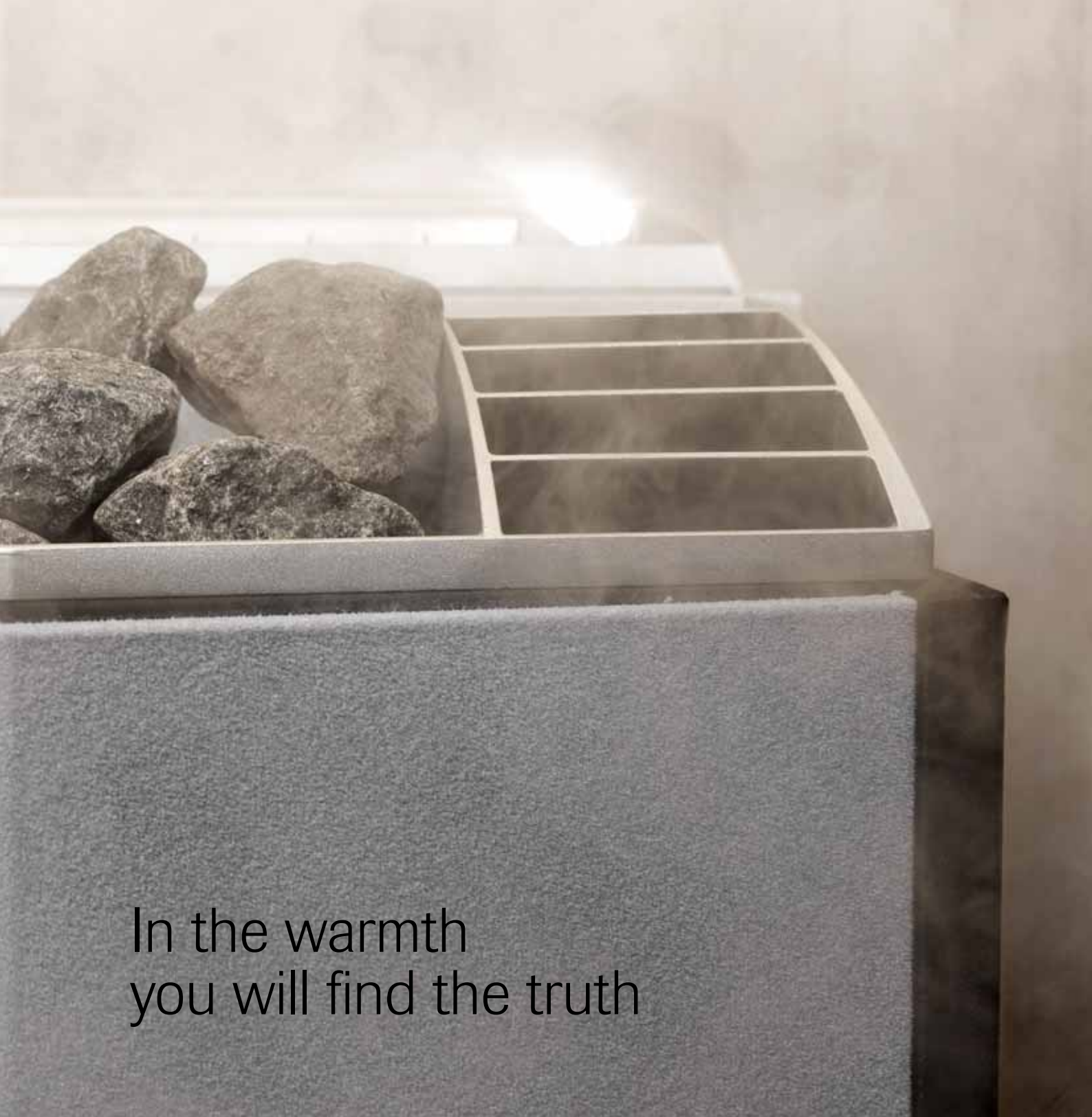

In the warmth you will find the truth

The heart of the sauna

Close your eyes, listen to what's inside you. Pour a ladle of water over the hot stones and listen to the hiss of the steam. The steam rises in a cloud that immerses you in pleasant heat. A liberating sensation. Our classic Tylö heater provides you with the pleasant experience of both a traditional sauna and a gentler steam sauna. Over the years, Tylö has been responsible for a series of revolutionary innovations that have improved the sauna environment. Our sleek heaters differ from other makes in many important aspects. You can see the difference in the design, the precision and the quality. Just look at the classic V-shaped front with its pure lines and the boldly designed grilles that effectively circulate the warm air. Experience the sensation, feel revitalized and refreshed.

Tylö sauna heaters

Over the years Tylö has pioneered numerous innovations to improve and develop the function, safety and enjoyment of sauna bathing. Today's Tylö heaters are the pinnacle of sauna technology, and our classic models excel over other brands in in many fundamental areas. You only have to look at the design, the precision and the quality of the finish to see that. But the difference in class really begins to show once the heater is switched on – and you can begin to switch off.

Classic sauna heater with integral control panel (excl. sauna stones)



Compact 2/4

(Art. no. 6220 2000, E-nr. 93 007 23)

A heater for small sauna rooms. Stone compartment for use with Mini sauna stones. With integral control panel at the base of the heater. With thermostat and mechanical timer. Max. 3 hours running time. 0-9 hour preset. 2.2-4.5 kW convertible for connection to 230 V (single-phase) or 400 V (two-phase with neutral).

For sauna rooms measuring 1.5-4.5 m².



www.tylo.com/compact



Sport 6

(Art. no. 6210 3009, E-nr. 93 007 51)

With integral control panel at the base of the heater. With thermostat and mechanical timer. Max. 3 hours running time. 0-9 hour preset. 6.6 kW output. Intended for sauna rooms measuring 4-8 m².

Sport 8

(Art. no. 6210 4009, E-nr. 93 007 52)

As above, but with 8 kW output. For sauna rooms measuring 6-12 m².



www.tylo.com/sport

Sauna heater with associated control panel (excl. sauna stones)



MPE 6

(Art. no. 6320 2009, E-nr. 93 007 24)

Comes with separate electronic control panel for mounting on the side of the heater, on a wall in the sauna room (max. 1 m above floor level) or at any height outside the sauna room. The control panel shows the time and temperature with LEDs on a scale of 1-10. Max. 3 hours running time. 0-10 hour preset. 6.6 kW output.



www.tylo.com/mpe

MPE 8

(Art. no. 6320 3009, E-nr. 93 007 25)

As above, but with 8 kW output. For saunas measuring 6-12 m².

Sauna heater for separate control panel, TS (excl. sauna stones)



SK 6

(Art. no. 6010 2009, E-nr. 93 007 46)

Requires separate thermostatic control panel, type TS. 6.6 kW output for saunas measuring 4-8 m².

SK 8

(Art. no. 6010 3009, E-nr. 93 007 48)

As above, but with 8 kW output for saunas measuring 6-12 m².



www.tylo.com/sk

Sauna heater for separate control panel, CC (excl. sauna stones)



SE 6

(Art. no. 6020 2019, E-nr. 93 007 26)

Requires separate electronic control panel, type CC. 6.6 kW output for saunas measuring 4-8 m².

SE 8

(Art. no. 6020 3019, E-nr. 93 007 27) As above, 8 kW output for saunas measuring 6-12 m².



www.tylo.com/se

SO 6

(Art. no. 6205 3003, E-nr. 93 007 00)

Integral control panel with thermostat and timer located on the top rear of the heater. Max. 3 hours running time. 0-9 hour preset. For wall mounting. 6 kW output. For sauna rooms measuring 4-8 m².

SO 8

(Art. no. 6205 3013, E-nr. 93 007 01)

As above, but with 8 kW output suitable for sauna rooms measuring 6-12 m².

Super 10

(Art. no. 6305 0133, E-nr. 93 006 04)

Has an electronic control panel easily accessible on the circular heater guard. Thermostat and timer. Max. 3 hours running time. 0-10 hour preset. For wall mounting. 10 kW output. For sauna rooms measuring 10-17 m².



www.tylo.com/so, www.tylo.com/super10



Select a gentler type of sauna bathing

Steam saunas at home

Steam saunas are a variation on the traditional sauna concept that we can warmly recommend. The difference is that you enjoy a steam sauna at a lower temperature, but with much higher humidity (up to 70%). In practice, this means a more gentle, more relaxing bathing sensation. To enjoy the relaxing properties of a steam sauna at home, simply choose a Tylö Combi heater. It's the perfect choice for all types of sauna bathing – dry, wet, or in clouds of soothing steam. And you can enhance the experience with the fragrance of natural herbs or liquid essences.

Sauna heater with associated control panel (excl. sauna stones)



Combi 4 RC

(Art. no. 6220 5000, E-nr. 93 007 31)

Heater for dry, traditional or steam sauna bathing. Comes with separate electronic control panel for wall-mounted installation inside the sauna room (max. 1 m above floor level) or at any height outside the sauna room. 4.5 kW output. 400 V (two-phase and neutral). For sauna rooms measuring 1.2–4.5 m³. Supplied complete with 2.5 m cable.

Combi 6 RC

(Art. no. 6220 5049, E-nr. 93 007 32)

As Combi 4 RC, but the control panel can also be placed on either side of the sauna heater itself. 6.6 kW output. For sauna rooms measuring 4–8 m³. Supplied complete with 2.5 m cable and bracket for installing the panel.

Combi 8 RC

(Art. no. 6220 5069, E-nr. 93 007 33)

As Combi 6 RC, but with 8 kW output. For sauna rooms measuring 6–12 m³.



www.tylo.com/combi



Sauna heater for professional use

For decades Tylo has been the obvious choice for saunas in hotels, clubs, swimming baths and sports facilities. Professionally managed environments like these prioritise reliability and low energy consumption, while frequent use subjects both designs and materials to punishing treatment.

Sauna heater for separate control panel (excl. sauna stones)



www.tylo.com/megaep100, www.tylo.com/megaeh150, www.tylo.com/megaez225

Mega EP 100

(Art. no. 6405 0003, E.nr. 93 007 03)

Requires separate control panel type TS 16, TS 30 or CC and relay box RB 30. Floor-mounted. 10 kW output. For sauna rooms measuring 10-17 m².

Mega EH 150

(Art. no. 6405 0023, E.nr. 93 007 04)

Requires separate control panel type TS 30 or CC and relay box RB 30. Floor-mounted. 15 kW output. For sauna rooms measuring 14-34 m². IMPORTANT! 7-core cable between control panel/relay box and heater.

Mega EZ 225

(Art. no. 6405 0053, E.nr. 93 007 06)

Requires separate control panel type TS 30 or CC and relay box RB 60. Floor-mounted. 22 kW output. For sauna rooms measuring 22-45 m². IMPORTANT! 7-core cable between control panel/relay box and heater.

Sauna heater for separate control panel (excl. sauna stones)



www.tylo.com/sd

SDK 10

(Art. no. 6420 1009, E-nr. 93 007 28)

Intended to be combined with separate control panel type TS 16, TS 30 or CC and relay box RB 30. 10.7 kW output. For sauna rooms measuring 10-18 m².

SD 16

(Art. no. 6420 3000, E-nr. 93 007 29)

Intended to be combined with separate control panel type TS 30 or CC and relay box RB 30. 16 kW output. For sauna rooms measuring 15-35 m². IMPORTANT! 7-core cable between control panel/relay box and heater.

SD 20

(Art. no. 6420 4000, E-nr. 93 007 30)

As above, but with 20 kW output. Combined with separate CC panel with relay box RB 60. For sauna rooms measuring 22-43 m². IMPORTANT! 7-core cable between control panel/relay box and heater.

Control panels

Electronic control panels CC



www.tylo.com/panels



CC 10

(Art. no. 7121 3000)

Electronic control panel for SE 6 and SE 8 heaters. Designed for wall-mounted installation outside the sauna. Max. 3-10 hours running time. 0-10 hour preset. Including external temperature sensor. (See installation instructions for location.) Size: 100 x 150 mm, depth 30 mm. IP 24.

CC10 Recessed

(Art. no. 7101 3040)

As above, but for installation recessed into the wall.



CC 20

(Art. no. 7121 3010)

Shows the time setting, temperature and humidity with LEDs on a scale of 1-10. Max. 3-10 hours running time. 0-10 hour preset. Size: 100 x 150 mm, depth 30 mm. IP 24.

CC 20 Recessed

(Art. no. 7101 3035)

As above, but for installation recessed into the wall.



CC 50

(Art. no. 7121 4005)

Display for time and temperature, switch for lighting, and security code function. Programmable for 1, 3, 12 and 24 hours or continuous operation. 0-10 hour preset. Size: 130 x 190 mm, depth 27 mm. IP 24.

Relay boxes

Relay box RB 30

(Art. no. 7101 6006)

Use with your choice of CC panel to control sauna heaters SK6, SK8, SDK10, SD16, Mega EP 100 and EH 150. Size: 230 x 310 mm, depth 75 mm.

Relay box RB 60

(Art. no. 7101 6007)

As above for sauna heater SD20 and Mega EZ 225. Size: 305 x 350 mm, depth 125 mm. OPTIONAL ACCESSORIES



CC 300

(Art. no. 7111 5150)

The CC 300 is switchable to run between 1 and 24 hours and has a display that indicates temperature, remaining operating time, day and time. In addition the CC 300 is equipped with a switch for lighting, English instructions, a memory, security code and energy-saving stand-by function. The control panel can also be controlled from external units. Size: 130 x 190 mm, depth 27 mm. IP 24.

Thermostatically controlled panels TS

TS 30-03

(Art. no. 7021 2010)

Thermostatically controlled panel for SDK 10 and SD 16 heaters. For wall installation outside the sauna room (max. distance 1.8 m). Fitted with timer for up to 3 hours running time. 0-9 hour preset. Standard capillary tube: 1.8 m. Size: 195 x 255 mm, depth 89 mm (installation size: 167 x 227 x 49 mm). IP 24.



TS 30-012

(Art. no. 7021 2020)

As above, but with 12 hours running time. No preset function.

TS 16-3

(Art. no. 7020 2000)

Control panel for SK 6 and SK 8 for wall-mounted installation outside the sauna room (max. distance 1.8 m). Robust, reliable construction with timer, 0-9 hour preset and max. 3 hours running time, thermostat and pilot lamp. Capillary tube: 1.8 m. Size: 195 x 255 mm, depth 89 mm (installation size: 167 x 227 x 49 mm). IP 24.

TS 16-3 B

(Art. no. 7020 2002) As above, with on/off switch for sauna lighting. TS panels are also available with 5-metre long capillary tubes.

5 m capillary tube

For the above panels TS 30-03 and TS 30-012.

Locking cover

Transparent acrylic. Suitable for all TS control panels.

Cover A

(Art. no. 9010 1000) Prevents unauthorised access to time and temperature settings.

Cover B

(Art. no. 9010 1010) Prevents unauthorised access to temperature setting.

External switch

(Art. no. 9090 8040)

On/off switch to control sauna from locations other than where the CC control panel is installed.

Decorative surround

(Art. no. 9000 1050) Matt brushed

(Art. no. 9000 1051) Gloss brushed

(Art. no. 9000 1052) High-gloss

Aluminium decorative surround for control panels CC50 and CC100. Size: 150 x 210 mm.





Wood-fired sauna stoves

There's something special about a wood-fired sauna, and as we know how to appreciate sauna bathing in all its forms here at Tylö, we have a wide range of wood-fired sauna stoves for you to choose from as well. They all share the same high quality and unique heat-retaining construction that means you can linger a little longer in the sauna. At home, in the country, or on the shores of a tranquil lake you can enjoy the advantages of a wood-fired sauna in a class of its own.



K-007
(Art. no. 6405 2000)
Compact model for small sauna rooms. 7 kW output. For saunas measuring 3-7 m³.



KL-12
(Art. no. 6405 1010)
With large glass hatch. 12 kW output. For saunas measuring 5-10 m³.

KL-12 V
(Art. no. 6405 1011) As above, with water tank on right-hand side.



KL-16
(Art. no. 6405 1020) With glass hatch. 15 kW output. For saunas measuring 9-16 m³.



KL-20
(Art. no. 6405 1030) With large glass hatch. 18 kW output. For saunas measuring 8-20 m³.

(Excl. Sauna stones, Wood-fired stove, Art. no. 9014 1007)



www.tylo.com/woodfiredsaunastoves

Sauna chimneys

We offer complete, high-quality chimney kits specially developed for use with Tylö wood-fired sauna stoves. Chimney kits are based on an easy-to-assemble modular system. Our modular chimney systems are used primarily with wood-fired sauna stoves in sauna rooms without an existing chimney, and for conversions and new constructions. The flues are manufactured in acid-resistant stainless steel, with high-grade ceramic insulation on the outside.

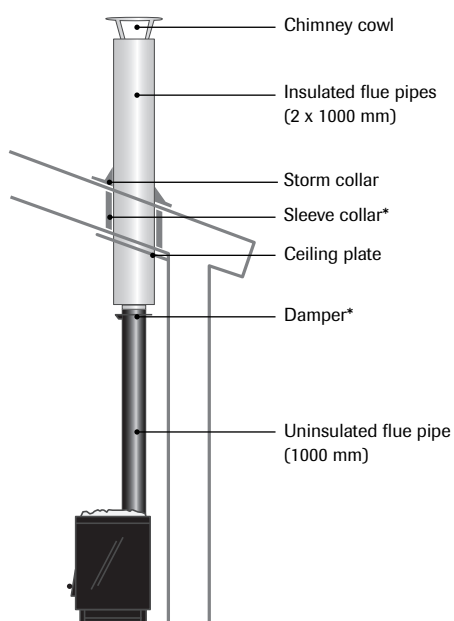

Sauna chimney kit Ø 100

(Art. no. 6505 3020)

Easy-to-assemble kit with 100 mm diameter flue suitable for Tylö wood-fired sauna stoves. Comprises a 1-metre uninsulated flue pipe, 2 x 1-metre insulated flue pipes, ceiling plate, storm collar and chimney cowl.

Insulated extension modules

100/1000 mm

(Art. no. 6505 3021)

Insulated intermediate section, length 1000 mm. Ø 100 mm.

100/500 mm

(Art. no. 6505 3022)

Insulated intermediate section, length 500 mm. Ø 100 mm.



Tylö sauna heaters – technically speaking

Always choose the highest recommended output in relation to the volume of the sauna. This is especially important in log saunas and saunas with glazed wall sections. The greater the heat output in relation to the size of the sauna room, the lower the overall energy consumption. This means, for example, that in a sauna room measuring 4 m³ a 6.6 kW heater is a better choice than a 4.5 kW heater.

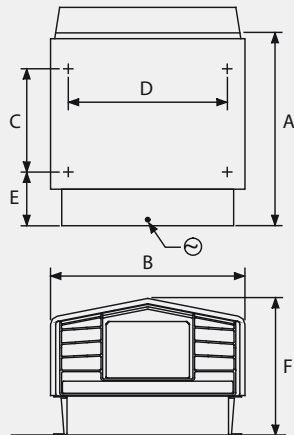

Install on the wall, with the bottom of the sauna heater 270 mm above the floor
(Compact and Combi RC4 170 mm).

Classic sauna heaters and control panels

Model	Output kW	Sauna volume m ³	Minimum distance to side wall mm	Minimum ceiling height in the sauna mm	Suitable control panel	Weight without stones kg	Weight of stones kg	Size in mm (see diagrams above)					
								A	B	C	D	E	F
Compact 2/4	2,2-4,5	1,2-4,5*	50	1900	Integral	6	7	400	310	195	260	135	170
Sport 6	6,6	4 - 8	110	1900	Integral	13	10	435	455	240	410	125	315
Sport 8	8	6 - 12	110	1900	Integral	15	12	505	455	240	410	170	315
MPE	6,6	4 - 8	110	1900	Included	13	10	435	455	240	410	125	315
MPE	8	6 - 12	110	1900	Included	15	12	505	455	240	410	170	315
SK 6	6,6	4 - 8	110	1900	TS 16 or TS 30	13	10	435	455	240	410	125	315
SK 8	8	6 - 12	110	1900	TS 16 or TS 30	15	12	505	455	240	410	170	315
SE 6	6,6	4 - 8	110	1900	Optional CC	13	10	435	455	240	410	125	315
SE 8	8	6 - 12	110	1900	Optional CC	15	12	505	455	240	410	170	315

* Max. 2.5 m³ at 2.2 kW.

Tylö Mega sauna heaters for domestic use

Model	Output kW	Sauna volume m ³	Minimum distance to side wall mm	Minimum ceiling height in the sauna mm	Suitable control panel and relay box	Distance from heater to floor mm	Weight without stones kg	Weight of stones kg	Size in mm width x depth x height
SO 6	6	4 - 8	50	1900	Integral	200	11	30	420 x 390 x 480
SO 8	8	6 - 12	80	1900	Integral	200	12	30	420 x 390 x 480
Super 10	10	10 - 17	100	1900	Integral	200	16	22	370 x 450 x 590



Steam saunas at home

Model	Output kW	Sauna volume m ³	Minimum distance to side wall mm	Minimum ceiling height in the sauna mm	Suitable control panel	Weight without stones kg	Weight of stones kg	Size in mm (see diagrams above)				
								A	B	C	D	E
Combi 4 RC	4,5	1,2-4,5	50	1900	CC 20 (included)	12	7	400	310	375	245	225
Combi 6 RC	6,6	4-8	110	1900	CC 20 (included)	16	10	435	455	405	360	355
Combi 8 RC	8	6-12	110	1900	CC 20 (included)	18	12	505	455	405	360	355

Mega sauna heaters for professional use

Model	Output kW	Sauna volume m ³	Minimum distance to side wall mm	Minimum ceiling height in the sauna mm	Suitable control panel and relay box	Distance from heater to floor	Weight without stones kg	Weight of stones kg	Size in mm width x depth x height
EP 100	10	10 - 17	80	1900	TS 16, CC + RB 30	-	11	25	360 x 420 x 650
EH 150	15	14 - 34	100	2300	TS 30, CC + RB 30	-	25	45	480 x 540 x 780
EZ 225	22	22 - 45	100	2300	TS 30, CC + RB 60	-	27	55	560 x 550 x 900

Classic sauna heaters for professional facilities

Model	Output kW	Sauna volume m ³	Minimum distance to side wall mm	Minimum ceiling height in the sauna mm	Suitable control panel	Weight without stones kg	Weight of stones kg	Size in mm (see diagrams above)					
								A	B	C	D	E	F
SDK 10	10,7	10 - 18	150	1900	TS 16, TS 30, CC + RB 30	30	25	570	650	310	600	165	395
SD 16	16	15 - 35	150	2100	TS 30, CC + RB 30	32	25	570	650	310	600	165	395
SD 20	20	22- 43	150	2100	CC + RB 60	32	25	570	650	310	600	165	395

Wood-fired sauna stoves

Sauna stove Model	Output kW	Sauna volume m ³	Water tank litres	Flue opening Ø mm	Distance from floor to bottom edge of rear flue	Weight without stones kg	Weight of stones kg	Size in mm width x depth x height
K-007	7	3 - 7	-	104	410 mm	32	25 - 30	330 x 430 x 600
KL-12	12	5-10	-	104	450 mm	48	40 - 45	410 x 500 x 660
KL-12 V	12	5-10	25	104	450 mm	53	40 - 45	575 x 500 x 660
KL-16	15	9 - 16	-	104	505 mm	55	40 - 45	435 x 490 x 710
KL-20	18	8 - 20	-	104	513 mm	62	60 - 65	480 x 500 x 780
KL-20 R	18	8 - 20	-	104	513 mm	62	60 - 65	480 x 500 x 780
KL-20 V	18	8 - 17	28	104	513 mm	67	60 - 65	645 x 500 x 780



Tylö dealers