

"Sense lets all your senses roam free with its fast, comfortable heat and smart Eco features."

1 2

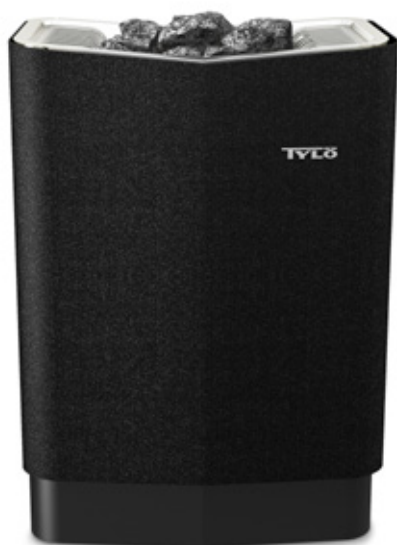

1 SENSE PLUS

Sense Plus is designed for installation with a separate electronic control panel. Choice of EC 50, CC50 or h1.

SENSE PLUS 6 KW
ITEM NO. 6100 1017

SENSE PLUS 8 KW
ITEM NO. 6100 1011

2 SENSE MPE

A control panel is included with the Sense MPE.

SENSE MPE 6 KW
ITEM NO. 6100 1030

SENSE MPE 8 KW
ITEM NO. 6100 1032

3 4

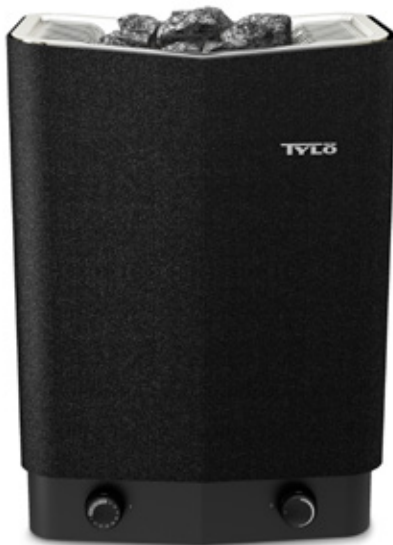

3 SENSE SPORT

Sense Sport is factory fitted with a time and temperature control knob on the front of the heater.

SENSE SPORT 6 KW
ITEM NO. 6100 1018

SENSE SPORT 8 KW
ITEM NO. 6100 1012

4 SENSE SK

Sense SK is designed for installation with a separate TS16 mechanical control panel or an EC50, CC50, h1 or RB30 electronic control panel.

SENSE SK 6 KW
ITEM NO. 6100 1025

SENSE SK 8 KW
ITEM NO. 6100 1027

5



5 SENSE COMBI

Enjoy dry, wet and steam saunas with just one heater - the Sense Combi crossover heater. The elegant h2 control panel is also included in its design.

SENSE COMBI 6 KW
ITEM NO. 6100 1016

SENSE COMBI 8 KW
ITEM NO. 6100 1010

LEGS FOR SENSE COMBI

ITEM NO. 9000 1061

LEGS FOR SENSE PLUS, SENSE MPE, SENSE SPORT AND SENSE SK

ITEM NO. 9000 1060

OPTION	COMBI	PLUS	MPE	SPORT	SK
Stand	+	+	+	+	+
Fragrances	+	+	+	+	+
Steam feature	▪	-	-	-	-
Mini sauna stones (20 kg)	+	+	+	+	+
Control panel	▪	+	▪	Integral	+

▪ = included + = optional - = not optional



COMBI - AS ITS NAME SUGGESTS

Combi is the heater that lets you enjoy dry, wet and steam saunas and has a built-in fragrance dispenser for aromatic essences.

GUARANTEED SAFE

Buying a prefabricated sauna room is not only the simplest and swiftest way to turn your dream of a sauna into reality. It's also the smartest and the safest, too. That way you can be sure of a really well-made sauna that will serve you well, year after year after year.

ELECTRONIC TOUCH CONTROL PANEL

The Combi heater features a stylish control panel from the h series. The control panel displays the time and temperature in the operating mode. You can set the temperature and control the humidity. set the start-up programme for the coming week with start repetition.

SAUNA HEATER: COMBI & COMPACT

Heaters for dry, steam or classic saunas. Separate electronic control panel for wall installation inside the sauna. The Combi heater adds a stylish look to your sauna with its aluminium top and stainless steel stone compartment. Equally sleek in design, the Compact has an integrated time and temperature control knob on its front and features a thermostat and mechanical timer.



OPTION	COMBI COMPACT 4	COMPACT 2/4
Stand	-	-
Fragrances	+	+
Steam feature	▪	-
Mini sauna stones (7 kg)	+	+
Control panel	▪	Integral

▪ = included + = optional - = not optional

❶ COMBI COMPACT 4

4 kW output. 400 V (two-phase and neutral). For sauna rooms measuring 1.2-4 m³. Supplied with a 2.5 m cable.
ITEM NO. 6230 5000

❷ COMPACT 2/4

A heater for small sauna rooms. Stone compartment for use with Mini sauna stones. 2.2-4.5 kW convertible for connection to 230 V (single-phase) or 400 V (two-phase with neutral). For sauna rooms measuring 1.5-4.5 m³.
ITEM NO. 6220 2000

SAUNA HEATER: **EXPRESSION**

1 2

Expression takes sauna heaters to a new level. Expression's Scandinavian design and clean-cut lines raise the bar for how good a sauna heater can look. Tylö's most recent design has won the international Red Dot Design award.



reddot design award



1 EXPRESSION

A floor-standing heater with robust aluminum legs and a reservoir for fragrance oil. Black. 10 kW output. 3 x 230 V, 3 x 400 V+N (requires RB30 + control panel at installation).

EXPRESSION 10 BLACK
ART. NO. 6100 1000

EXPRESSION 10 CHAMPAGNE
ART. NO. 6100 1003

EXPRESSION 10 COPPER
ART. NO. 6100 1006

2 EXPRESSION COMBI

Same as Expression but with steam feature. Comes with a touch control panel from Tylö's h series. Output 10 kW. 3 x 230 V, 3 x 400 V+N. Permanent water supply required.

EXPRESSION COMBI BLACK
ART. 6200 1000

EXPRESSION COMBI COPPER
ART. 6200 1016

EXPRESSION COMBI CHAMPAGNE
ART. 6200 1013

EXTRA FEATURES FROM THE START

As well as stylish looks, Expression sports the same quality features as other Tylö heaters: twin-side air chambers for enhanced warm air distribution, a fragrance dispenser and double-shell design. Expression also incorporates Tylö's energy-saving "divided output" feature. This means the heater automatically switches to energy-saving mode when the temperature reaches the required level.

INTEGRAL STEAM SAUNA FEATURE

Expression Combi also has a steam feature for a relaxing steam sauna. Water supply and drainage through mains connection.

AWARD-WINNING DESIGN

The Red Dot Design Award is an international distinction for outstanding design, conferred annually by Design Zentrum Nordrhein Westfalen. The award is sometimes also referred to as the "Nobel Prize for Designers".



OPTION	EXPRESSION	EXPRESSION COMBI
Stand	▪	▪
Fragrances	-	▪
Steam feature	-	▪
Sauna stones (1 packet)	+	+
Control panel and relay box	+	▪

▪ = included + = optional - = not optional

SAUNA HEATER IN TECHNICAL TERMS

Always choose the highest recommended output in relation to the volume of the sauna. This is especially important in log saunas and saunas with glazed wall sections. The greater the heat output in relation to the size of the sauna room, the lower the overall energy consumption. Example: In a sauna measuring 4 m³, 6.6 kW is a better choice than 4.5 kW.

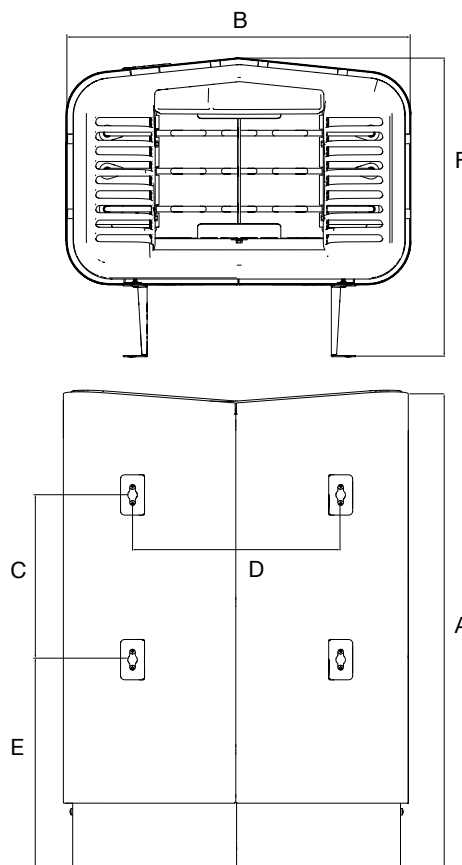

PRACTICAL WALL INSTALLATION – SIMPLE CLEANING

Install the heater on the wall, with the bottom edge 270 mm above the floor (170 mm for Compact and Combi 4).

SAUNA HEATER

MODEL	OUTPUT (KW)	SAUNA VOLUME (M ³)	MINIMUM DISTANCE TO SIDE WALL (MM)	MINIMUM CEILING HEIGHT IN THE SAUNA (MM)
Sense Combi 6	6.6	4 – 8	110	1900
Sense Combi 8	8	6 – 12	110	1900
Sense Plus 6	6.6	4 – 8	110	1900
Sense Plus 8	8	6 – 12	110	1900
Sense MPE 6	6.6	4 – 8	110	1900
Sense MPE 8	8	6 – 12	110	1900
Sense Sport 6	6.6	4 – 8	110	1900
Sense Sport 8	8	6 – 12	110	1900
Sense SK 6	6.6	4 – 8	110	1900
Sense SK 8	8	6 – 12	110	1900
Compact 2/4	2.2 – 4.5	1.2 – 4.5**	50	1900
Combi 4	4	1.2 – 4.5	50	1900
Expression	10	10 – 18	200	1900
Expression Combi	10	10 – 18	200	1900

*The TS controls do not require a relay box (RB). **Max 2.5 m³ at 2.2 kW.

	SUITABLE CONTROL PANEL	WEIGHT WITHOUT STONES (KG)	WEIGHT OF STONES (KG)	SIZE IN MM (SEE DIAGRAMS)					
				A	B	C	D	E	F
	h2 (included)	23	20	559	431	308	298	185	375
	h2 (included)	23.5	20	559	431	308	298	185	375
	CC50, EC50, h1	17	20	559	431	308	298	185	375
	CC50, EC50, h1	17.5	20	559	431	308	298	185	375
	included	17	20	559	431	308	298	185	375
	included	17.5	20	559	431	308	298	185	375
	Integral	16	20	559	431	308	298	185	375
	Integral	16.5	20	559	431	308	298	185	375
	h1, EC50, CC50 + Relay box 30	16	20	559	431	308	298	185	375
	h1, EC50, CC50 + Relay box 30	16.5	20	559	431	308	298	185	375
	Integral	6	7	400	310	195	260	135	170
	h1 (included)	12	7	400	310	-	245	-	225
	h1, CC50, CC300 + RB 30	29	12	730	500	-	-	-	300
	h2 + relay box (included)	32	12	730	500	-	-	-	300

SAUNA HEATER FOR PROFESSIONAL USE

For decades, Tylö has been the obvious choice for saunas in hotels, clubs, swimming baths and sports facilities. Settings like these prioritise reliability and low energy consumption, and both the design and materials need to be robust enough to stand up to the rigours of frequent use.



1 TYLÖ MEGALINE OC

The robust Megaline OC follows a proven tradition of excellence and can be installed in all kinds of saunas - even in the centre of your sauna if you want. Designed for saunas of 9 to 24 m³. The slightly smaller Megaline OC 10 kW is suitable for saunas of 9 to 13 m³. The elegant H2 control panel and the WE14 relay box control all the sauna features.

TYLÖ MEGALINE OC 10.5 KW
ITEM NO. 6405 0230

TYLÖ MEGALINE OC 12 KW
ITEM NO. 6405 0234

TYLÖ MEGALINE OC 15 KW
ITEM NO. 6405 0235

2 TYLÖ MEGALINE SK

For saunas between 18 and 46 m³. A steam generator can be connected to the SK heater to further enhance your sauna experience. Choose a traditional, deeply warming dry sauna or a soothing steam bath. The SK heater is an outstanding choice for public saunas, where expectations for a pleasurable sauna experience are high. Set-up is simple with the H2 control panel, which controls the sauna in conjunction with the WE14 relay box.

TYLÖ MEGALINE SK 18 KW
ITEM NO. 6405 0236

TYLÖ MEGALINE SK 21 KW
ITEM NO. 6405 0238

TYLÖ MEGALINE SK 26 KW
ITEM NO. 6405 0240

3 SDK 10

Intended to be combined with separate control panel type TS 16, TS 30 or CC and relay box RB 30. 10.7 kW output. For sauna rooms measuring 10-18 m³. Width 650 mm, depth 395 mm, height 570 mm.

ITEM NO. 6430 1009

3 SD 16

Intended to be combined with a separate control panel TS 30 or CC and relay box RB 30. 16 kW output. For sauna rooms measuring 15-35 m³. NB! 7-core cable between control panel/relay box and heater. The RB 60 is recommended for use in public areas.

ITEM NO. 6430 3000

3 SD 20

Combine with a separate CC panel and RB 60 relay box. 20 kW output. For sauna rooms measuring 22-43 m³. NB! 7-core cable between control panel/relay box and heater.

ITEM NO. 6430 4000



PROFESSIONAL SAUNA HEATER IN TECHNICAL TERMS

Always choose the highest recommended output in relation to the volume of the sauna. This is especially important in log saunas and saunas with glazed wall sections. The greater the heat output in relation to the size of the sauna room, the lower the overall energy consumption. Example: In a sauna measuring 4 m³, 6.6 kW is a better choice than 4.5 kW.

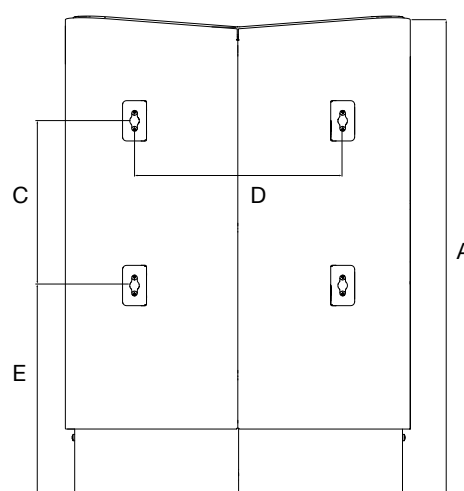
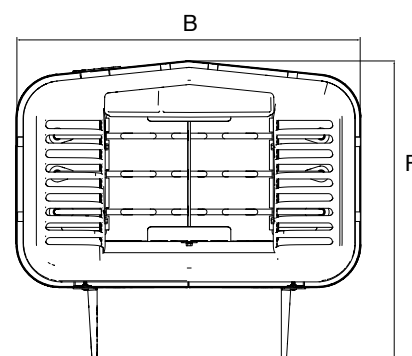

PRACTICAL WALL INSTALLATION - SIMPLE CLEANING

Install the heater on the wall, with the bottom edge 270 mm above the floor (170 mm for Compact and Combi 4).

SAUNA HEATER FOR PROFESSIONAL USE

MODEL	OUTPUT (KW)	SAUNA VOLUME (M ³)	MINIMUM DISTANCE TO SIDE WALL (MM)	MINIMUM CEILING HEIGHT IN THE SAUNA (MM)
Tylö Megaline OC 10	10.5	9 – 15	25	1900
Tylö Megaline OC 12	12.0	10 – 18	65	2100
Tylö Megaline OC 15	15.0	14 – 24	65	2100
Tylö Megaline SK 18	18.0	18 – 30	140	2100
Tylö Megaline SK 21	21.0	24 – 36	140	2100
Tylö Megaline SK 26	26.0	30 – 46	140	2100
SDK 10	10.7	10 - 18	150	1900
SD 16	16	15 – 35	150	2100
SD 20	20	22 – 43	150	2100

	SUITABLE CONTROL PANEL	WEIGHT WITHOUT STONES (KG)	WEIGHT OF STONES (KG)	SIZE IN MM (SEE DIAGRAMS)					
				A	B	C	D	E	F
	h1, CC-50, CC-10, CC-300 + RB30	29	12	730	500	-	-	-	300
	h2 + relay box WE 14	27	60	700	550	-	-	-	550
		28	60	700	550	-	-	-	550
		29	60	700	550	-	-	-	550
		41	120	700	895	-	-	-	520
		42	120	700	895	-	-	-	520
		44	120	700	895	-	-	-	520
	TS 16, TS 30, CC + RB 30	30	25	570	650	310	600	165	395
	TS 30, CC + RB 30	32	25	570	650	310	600	165	395
	CC + RB 60	32	25	570	650	310	600	165	395

SAUNA HEATER: **CONTROL PANEL**

There are a number of different control panels for Tylö heaters offering a wide range of individual setting options. All control panels are user-friendly with clear displays that allow you to customise your sauna for optimal performance and energy efficiency.



FUNCTIONS

Tylö's stylish h1 control panel makes it easy to adjust the sauna or steam bath.

SETTINGS

CURRENT STATUS

HOME

UP/DOWN

BACK

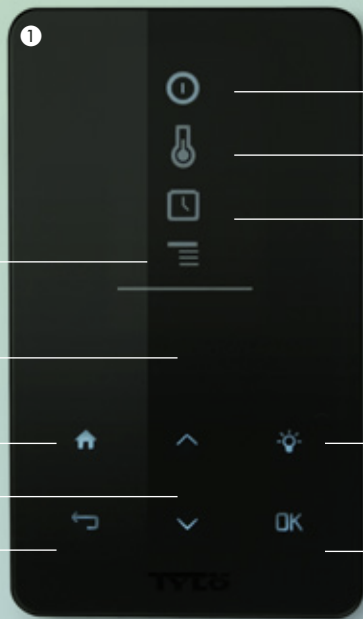

ON/OFF

TEMPERATURE

START TIME, SELECTED PROGRAMME

LIGHTING

OK

1 h1

Electronic touch control panel displays the time and temperature in the operating mode. Can be programmed to start up to 24 hours in advance and run for 1 to 23 hours for a steam room and 1 to 12 hours for a sauna. The control panel also allows you to regulate the lighting in your sauna. Tylö's h1 control panel lets you set the maximum temperature, switch between Fahrenheit and Celsius, use a 12-hour or 24-hour format, set different languages, and more advanced settings and test options. Tylö's h1 control panel can replace Tylö's CC10 and CC50 control panels. Size: 140 x 80 mm, depth 19 mm.

ITEM NO. 7200 1020

2 EC50

Tylö's EC50 control panel makes it simple and economical to have complete control of your sauna and steam sauna. It has an easy-to-read display for convenient control of the start-up time, temperature and lighting. The panel incorporates a child-proof code lock to prevent accidental operation. Compatible with the following heaters and steam generators: Sense Plus, SD, SDK, VB and VA. Size: 130 x 190 mm, depth 27 mm. IP 24.

ITEM NO. 7121 4050

3 CC300

The CC300 can be set to run between 1 and 24 hours and has a display that indicates temperature, remaining operating time, day and time. In addition, the CC300 comes with a switch for lighting, English instructions, memory features, security

code and energy-saving, stand-by function. The CC300 has an integral weekly timer for optional automatic on/off operation and stand-by mode at preselected times on the days of your choice. The control panel can also be controlled from external units. Size: 130 x 190 mm, depth 27 mm. IP 24.

ITEM NO. 7111 5150

4 CC300T

The CC300T can be set to run between 1 and 24 hours and has a display that indicates temperature, humidity, remaining operating time, day and time. In addition, the CC300T is equipped with a switch for lighting, English instructions, a memory, security code and energy-saving, stand-by function. The CC300T has an integral weekly timer for optional automatic on/off operation and stand-by mode at preselected times on the days of your choice. The control panel can also be controlled from external units. Size: 130 x 190 mm, depth 27 mm. IP 24.

ITEM NO. 7111 5155

EXTERNAL SWITCH

On/off switch to control the sauna from locations other than where the control panel (not the TS control panel) is installed. Indicator light shows if the sauna is on or off. Fits standard wall mounting box recessed or surface mounted. Size: 80 x 80 x 47mm

ITEM NO. 9090 8045





STEAM BATH: **STEAM GENERATOR**

Leave the daily challenges behind you and enjoy the perfect end to a day. Give yourself some me-time in the steam. Tylö has a strong tradition of providing steam generators for public and private use. Our latest series is fitted with a state-of-the-art control unit to ensure precise operation. Control the steam, lights, timer and other features at the simple touch of a button. Add fragrances and relax. Indulge yourself and all your senses.

WHAT'S INCLUDED

Automatic empty
Automatic flush
Energy-saving feature
Replaceable heater
Limescale repellent electrodes
Level detection outside the water tank
Automatic shut-off at low water level
Electronic temperature limiter
Stand by
Fragrance pump control
Fan control

MODEL	OUTPUT (KW)	
PRO 9	9	
PRO 12	12	
2/4/6 VB*	2.2	
	4.5	
	6.6	
6 VA	6	
9 VA-K	9	
12 VA	12	
18 VA	18	
24 VA	24	
3x9 VA**	27	
3x12 VA**	36	



1 STEAM VA

A powerful, fully automatic steam generator with a large water tank, making it ideal for public facilities. Requires connection to electricity and water supplies. Convertible 1-phase/3-phase. IP rating: IP 45. Add your choice of control panel.

STEAM 6 VA
ITEM NO. 6620 2020

STEAM 9 VA-K
ITEM NO. 6620 3021

STEAM 12 VA
ITEM NO. 6620 4020

STEAM 18 VA
ITEM NO. 6620 5020

STEAM 24 VA
ITEM NO. 6620 6020

1-phase/3-phase. IP rating: IP 21. The H1 control panel is always included with the Steam PRO and you can add another if you wish.

9 PRO
ITEM NO. 6620 7000

12 PRO
ITEM NO. 6620 7010



3 STEAM 2/4/6 VB

A compact steam generator with the same high-quality materials, functions and features as the VA models, but with a smaller water tank to ensure rapid heating. Designed for small and medium-sized home steam rooms. IP rating: IP 23. Add your choice of control panel.

ITEM NO. 6620 1830



2 STEAM PRO

Tylö's PRO is a reliable and service-friendly steam generator that meets all needs for public facilities. It also measures the water quality and, if the quality is not good enough, its embedded failure protection system empties the tank, rinses it clean and refills it, with minimal interruption in steam production. For the sake of safety, the steam generator is also equipped with features such as an overpressure valve and temperature protection. Convertible

THE STEAM ROOM'S MIN./MAX. VOLUME (M ³)				STEAM PRODUCTION (KG/H)	SIZE IN MM (LXWXH)	SUITABLE CONTROL PANEL
Light wall made of glass, plastic, Elysée Excellent room, etc.		Heavy wall made of tiles, concrete, stone, etc.				
with ventilation	without ventilation	with ventilation	without ventilation			
6 – 16	13 – 24	4 – 10	7 – 16	12	470 x 600 x 1160	h1 PRO (included)
14 – 22	22 – 30	8 – 15	14 – 20	16	470 x 600 x 1160	
– max. 4 3 – 8	max. 2.5 max. 5.5 4 – 15	– max. 2.5 2 – 5	max. 1.5 max. 3.3 2.5 – 8	3 5.5 8	445 x 130 x 415	CC50, CC300 and h1
3 – 8	4 – 15	2 – 5	2.5 – 8	8	570 x 224 x 485	
6 – 16	13 – 24	4 – 10	7 – 16	12	570 x 224 x 485	
14 – 22	22 – 30	8 – 15	14 – 20	16	570 x 224 x 485	
20 – 30	28 – 40	13 – 20	18 – 30	24	615 x 445 x 485	
28 – 40	38 – 50	18 – 30	28 – 40	32	615 x 445 x 485	
38 – 45	46 – 60	28 – 40	38 – 52	36	570 x 224 x 485	
43 – 60	58 – 70	38 – 50	48 – 60	48	570 x 224 x 485	

* 2.2/4.5/6.6 kW convertible for single, two or three phase connection. ** Only one control panel is required for connection.

OPTIONAL & ACCESSORIES: **CONTROL PANEL**

The many different control panels for Tylö's steam rooms offer a great range of individual options. All control panels are user-friendly with clear displays that allow you to customise your sauna for optimal performance and energy efficiency.



FUNCTIONS

Tylö's stylish h1 control panel makes it easy to adjust the sauna or steam bath.

SETTINGS

CURRENT STATUS

HOME

UP/DOWN

BACK

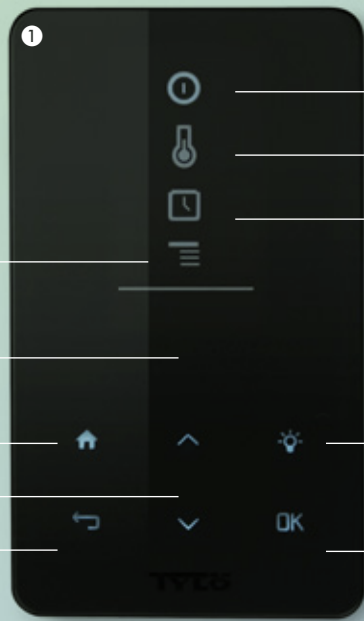

ON/OFF

TEMPERATURE

START TIME, SELECTED PROGRAMME

LIGHTING

OK

1 h1

Electronic touch control panel displays the time and temperature in the operating mode. Can be programmed to start up to 24 hours in advance and run for 1 to 23 hours for a steam room and 1 to 12 hours for a sauna. The control panel also allows you to regulate the lighting in your sauna. Tylö's h1 control panel lets you set the maximum temperature, switch between Fahrenheit and Celsius, use a 12-hour or 24-hour format, set different languages, and more advanced settings and test options. Tylö's h1 control panel can replace Tylö's CC10 and CC50 control panels. Size: 140 x 80 mm, depth 19 mm.

ITEM NO. 7200 1020

2 EC50

Tylö's EC50 control panel makes it simple and economical to have complete control of your sauna and steam sauna. It has an easy-to-read display for convenient control of the start-up time, temperature and lighting. The panel incorporates a child-proof code lock to prevent accidental operation. Compatible with the following heaters and steam generators: Sense Plus, SD, SDK, VB and VA. Size: 130 x 190 mm, depth 27 mm. IP 24.

ITEM NO. 7121 4050

3 CC300

The CC300 can be set to run between 1 and 24 hours and has a display that indicates temperature, remaining operating time, day and time. In addition, the CC300 comes with a switch for lighting, English

instructions, memory features, security code and energy-saving, stand-by function. The CC300 has an integral weekly timer for optional automatic on/off operation and stand-by mode at preselected times on the days of your choice. The control panel can also be controlled from external units. Size: 130 x 190 mm, depth 27 mm. IP 24.

ITEM NO. 7111 5150

4 CC300T

The CC300T can be set to run between 1 and 24 hours and has a display that indicates temperature, humidity, remaining operating time, day and time. In addition, the CC300T is equipped with a switch for lighting, English instructions, a memory, security code and energy-saving, stand-by function. The CC300T has an integral weekly timer for optional automatic on/off operation and stand-by mode at preselected times on the days of your choice. The control panel can also be controlled from external units. Size: 130 x 190 mm, depth 27 mm. IP 24.

ITEM NO. 7111 5155

EXTERNAL SWITCH

On/off switch to control the sauna from locations other than where the control panel (not the TS control panel) is installed. Indicator light shows if the sauna is on or off. Fits standard wall mounting box recessed or surface mounted. Size: 80 x 80 x 47 mm

ITEM NO. 9090 8045



OPTIONAL & ACCESSORIES

Step into the steam and reveal who you are. Express your personality with a few well selected accessories. Personal style is paramount at Tylö. Our Scandinavian designers challenge themselves to design accessories that are an aesthetic statement. Ever since our founder Sven-Olof Janson made his first sauna in the 1950s, we have unveiled one ground-breaking innovation after another. Every little detail is infused with consideration and love. Open the door and discover for yourself. It's all in the details.



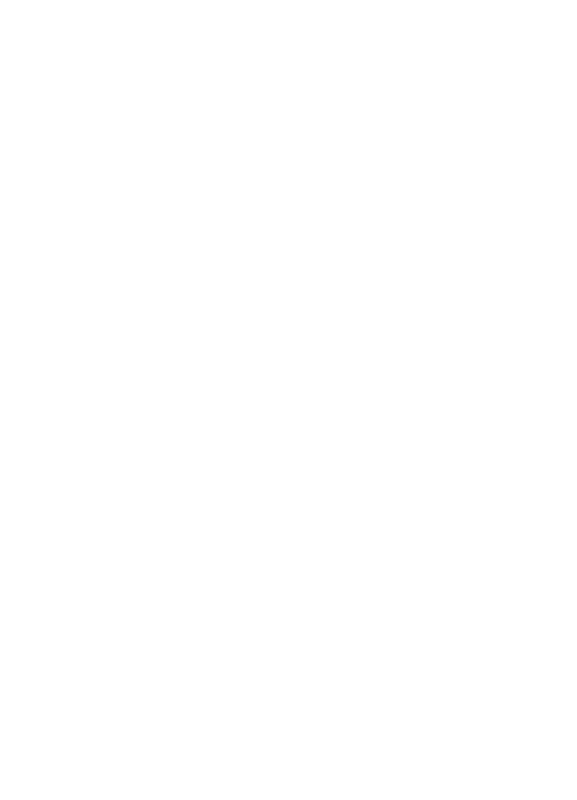

MEDITATIVE STARLIGHT

Spread a meditative, starlit mood in your sauna with our starry sky LED lighting. Select a colour that suits the occasion and matches the interior of the sauna.

TYLÖ'S STEAM HEADS

Step into the warmth, feel the steam caress your skin. Your muscles relax and the tension melts away. Your mind clears and your dreams come to life. A liberating feeling. The steam head illustrated has an integral dispenser for Tylö fragrances.



ADD SOUND

Enhance the feeling of calm and relaxation when you take a steam bath. Tylö's steam baths can be customised in many ways to suit the most diverse tastes. One of the favourite accessories for the Tylö Elysée is the steam and heat-proof sound system. This is available in two versions; one for mounting under the benches and one for mounting on the outside of the glass.

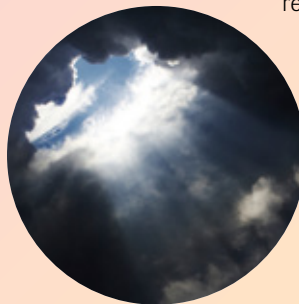



TYLÖ HINGED DOORS

Our hinged doors for showers and steam rooms have an extra robust design to cope with wear and tear and heavy traffic in demanding environments such as public bathing facilities. They are manufactured in 6 mm tempered, safety glass with protective stainless steel trim round the edges and hung in a robust aluminium frame. Door leaves come complete with aluminium handles and hinges, and magnetic strips for a tight seal. There is a drainage strip and air vent at the base of the door. All can be hung to open either left or right. We can deliver doors in special sizes.

1 STEAM DOOR 50 G

Compact model in tempered clear glass with concealed hinges. Frame size: 1855 x 635 x 43 mm. Width of opening: 550 mm.

ITEM NO. 9091 1010

2 STEAM DOOR 60 G

Tempered glass door. Opening width: 670 mm.

TINTED GLASS WITH ALUMINIUM FRAME

2100 x 778 x 60 mm
ITEM NO. 9091 2040

TINTED GLASS WITH ALUMINIUM FRAME

1870 x 778 x 60 mm
ITEM NO. 9091 2000

TINTED GLASS WITH WHITE FRAME

1870 x 778 x 60 mm
ITEM NO. 9091 2003

CLEAR GLASS WITH ALUMINIUM FRAME

1870 x 778 x 60 mm
ITEM NO. 9091 2001

CLEAR GLASS WITH WHITE FRAME

1870 x 778 x 60 mm
ITEM NO. 9091 2005

STEAM DOOR 60 G 2020 WITH ALUMINIUM FRAME AND TINTED GLASS

2020 x 780 x 60 mm
ART.NR. 9091 4000

STEAM DOOR 60 G 2020 WHITE FRAME TINTED GLASS

2020 x 780 x 60 mm
ART.NR. 909 1405

3 STEAM DOOR 101 G

Tempered, tinted safety glass door specially adapted for wheelchair access with an extra wide opening and flat sill. Frame size: 1870 x 1010 x 60 mm. Width of opening: 900 mm.

RIGHT-HINGE DOOR WITH TINTED GLASS AND ALUMINIUM FRAME

ITEM NO. 9091 2025

LEFT-HINGE DOOR WITH TINTED GLASS AND ALUMINIUM FRAME

ITEM NO. 9091 2030

RIGHT-HINGE DOOR WITH TINTED GLASS AND WHITE FRAME

ITEM NO. 9091 2027

LEFT-HINGE DOOR WITH TINTED GLASS AND WHITE FRAME

ITEM NO. 9091 2032

4 STEAM GUARD

Made of vacuum-formed, special-grade white plastic. Can be ordered instead of the standard wall/seat section at no extra charge.

STEAM GUARD 778

For 778 mm section in the Elysée room.

ITEM NO. 9002 9220

STEAM GUARD 588

For 588 mm section.

ITEM NO. 9002 9230

STEAM GUARD CORNER

For corner sections.

ITEM NO. 9002 9240

5 TYLÖ FRESH FRAGRANCE DISPENSER

Fragrance dispenser for saunas, steam baths and wherever you wish to enjoy Tylö's aromatic essences. Operates silently and automatically. Installation distance: max. two metres between fragrance dispenser and steam head. Tip! Up to